



5

DEATH,
BE NOT
PROUD

86

[EIGHTY-
SIX]



ASATO
ASATO

ILLUSTRATION:
Shirabii
MECHANICAL DESIGN:
I-IV



5

DEATH, BE NOT PROUD

**ASATO
ASATO**

ILLUSTRATION:

Shirabii

MECHANICAL DESIGN:

I-IV



NEW YORK



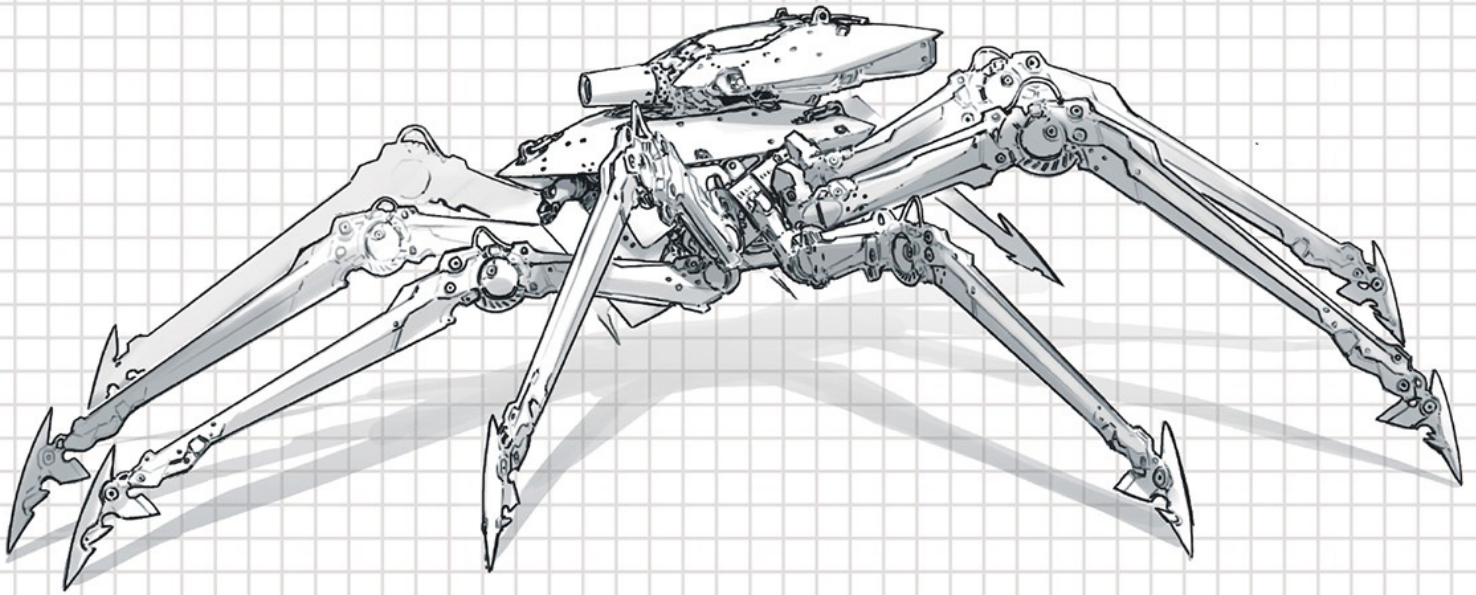

The United Kingdom of Roa Gracia's Semiautonomous Weapon

Alkonost

[S P E C S]

Manufacturer: Sixth Royal Technological
Department Factory

Total Length: 4.2 m / Height: 1.8 m

[F I X E D A R M A M E N T S]

Primary Armament: 105 mm Gun/Launcher
[for Anti-Tank Missiles, Explosive Ammunition usage]

Secondary Armament: 14 mm Heavy Machine Gun
[coaxial with main armament, equipped on the right]

The Feldreiß that makes up the bulk of the United Kingdom of Roa Gracia's military. A unit designed for combat on snowy fields, on icy surfaces, and in cold regions. It has ten thin, long legs equipped with talons that stab into the terrain in order to move.

It has a small, extremely light armored design, allowing it a mobility exceeding that of the Federacy's Reginleif. A direct result of that, however, is that it places very little importance on the survival of those on board. Despite this, the unit is widely deployed in the United Kingdom, but there is a reason for that...

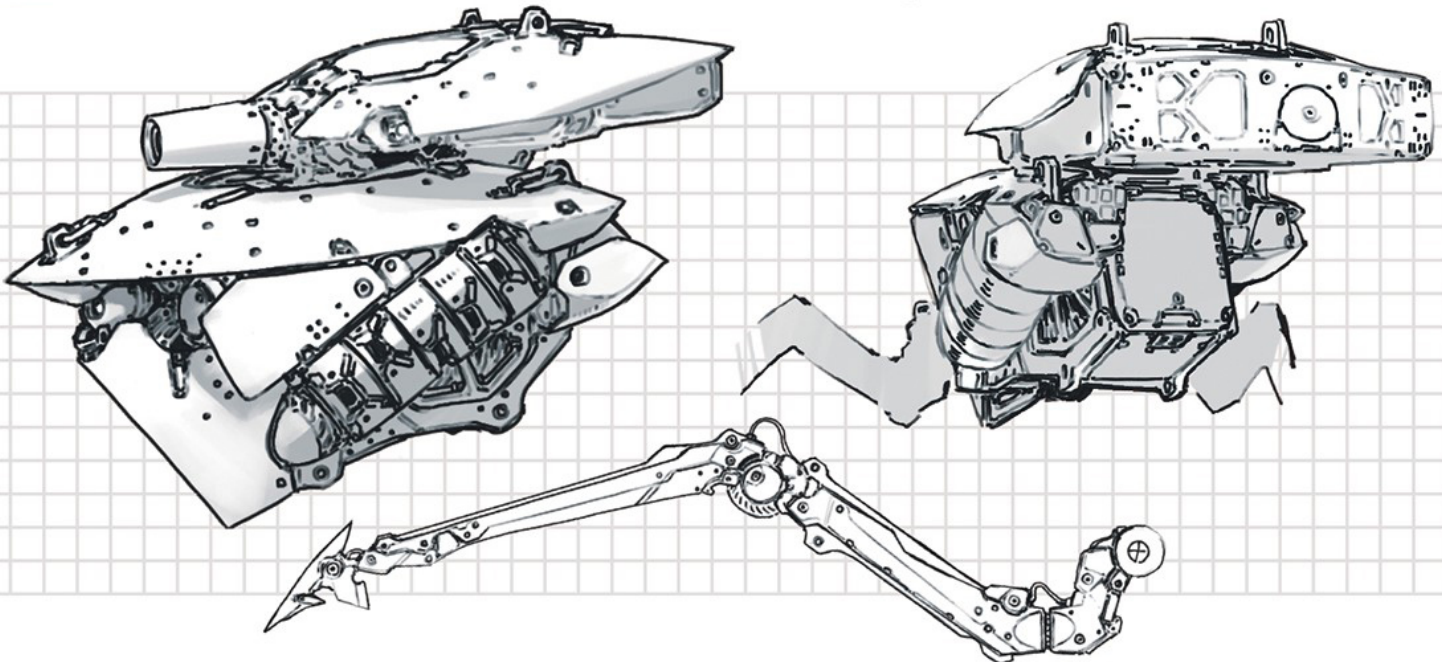

E I G H T Y · S I X



86
A MONSTER
LIVES
IN A NORTHERN
COUNTRY.

The northern country.
A frozen world
covered in snow and
forests, ice and rocks.
Setting foot into this land,
they find their own
survival put to the test.

In these snowy fields,
monsters jeer.
They are foe but also friend.
Their lesson:
In order to know life,
one must also know death.

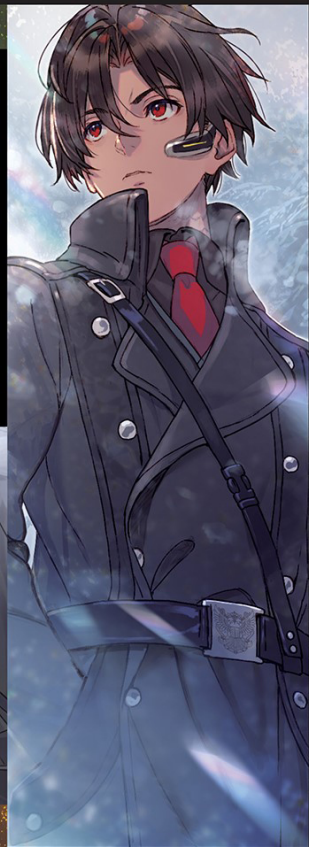

The Eighty-Sixth Strike Package's Primary Feldreiß

XM2 Reginleif

EIGHTY-SIX

Life, land, and legacy.
All reduced to a number.

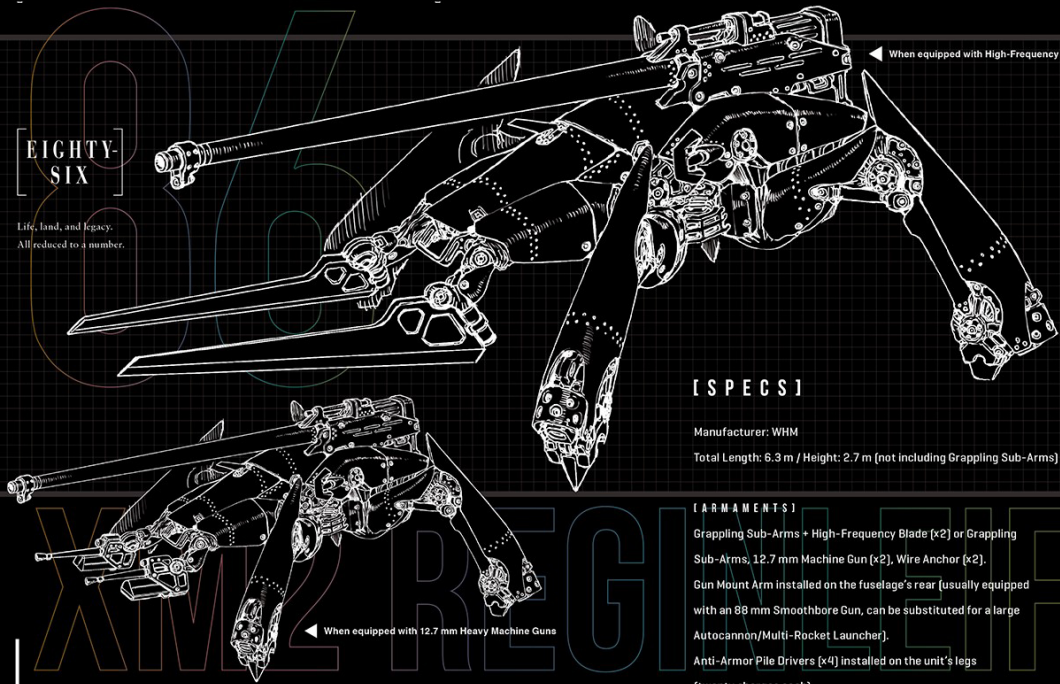

A Feldreiß (Polypedal Armored Weapon) designed for high-mobility combat. Developed by Colonel Wenzel of the Federacy military, using the Republic of San Magnolia's mobile weapon the M1A4 Juggernaut as a reference.

They have a tendency to pick their pilots, often the Eighty-Six survivors of the Republic's battlefields (who continue to affectionately—and ironically—call them Juggernauts).

[SPECS]

Manufacturer: WHM

Total Length: 6.3 m / Height: 2.7 m (not including Grappling Sub-Arms)

[ARMAMENTS]

Grappling Sub-Arms + High-Frequency Blade [x2] or Grappling Sub-Arms, 12.7 mm Machine Gun [x2], Wire Anchor [x2].

Gun Mount Arm installed on the fuselage's rear (usually equipped with an 88 mm Smoothbore Gun, can be substituted for a large Autocannon/Multi-Rocket Launcher).

Anti-Armor Pile Drivers [x4] installed on the unit's legs (twenty charges each).

A monster lives in a northern country.



Shinei Nouzen UNDERTAKER

Usually deploys with Sub-Arms: High-Frequency Blades [x2] and Gun Mount Arm: 88 mm Smoothbore Gun. When engaging in close-quarters combat, has a very high probability of damaging the unit but returns alive every time.



Raiden Shuga WEHRWOLF

Sub-Arms: 12.7 mm Heavy Machine Gun [x2]; Gun Mount Arm: 40 mm Autocannon Barrage Deployment Model. Provides assistance for Shin and covering fire for rear guard like Kurena and Anju.



Kurena Kukumila GUNSLINGER

Sub-Arms: 12.7 mm Heavy Machine Gun [x2]; Gun Mount Arm: 88 mm Smoothbore Gun (Long-Barrel Variant). Specialized for sniping. Has especially augmented altitude- and fire-control systems.



Theoto Rikka LAUGHING FOX

Orthodox setup of Sub-Arms: 12.7 mm Heavy Machine Gun [x2]; Gun Mount Arm: 88 mm Smoothbore Gun. Taking advantage of his lack of specialization, he employs wire anchors to achieve high-mobility combat.



Anju Emma SNOW WITCH

Sub-Arms: 12.7 mm Heavy Machine Gun [x2]; Gun Mount Arm: Multiple-Missile Pad for suppressing fire. Exceeding the others in terms of sheer firepower, she often takes the vanguard when attacking groups of enemies.

THE EIGHTY-SIX'S PERSONAL ARMAMENTS

Life, land, and legacy.
All reduced to a number.

86

[EIGHTY-
SIX]

A monster lives in a northern country.

5 DEATH, BE NOT PROUD

ASATO ASATO

ILLUSTRATION: Shirabii

MECHANICAL DESIGN: I-IV

[Copyright](#)

86—EIGHTY-SIX

Vol. 5

ASATO ASATO

Translation by Roman Lempert
Cover art by Shirabii

This book is a work of fiction. Names, characters, places, and incidents are the product of the author's imagination or are used fictitiously. Any resemblance to actual events, locales, or persons, living or dead, is coincidental.

86—Eighty-Six—Ep. 5

©Asato Asato 2018

Edited by Dengeki Bunko

First published in Japan in 2018 by KADOKAWA CORPORATION,
Tokyo.

English translation rights arranged with KADOKAWA
CORPORATION, Tokyo, through TUTTLE-MORI AGENCY, INC.,
Tokyo.

English translation © 2020 by Yen Press, LLC

Yen Press, LLC supports the right to free expression and the value of copyright. The purpose of copyright is to encourage writers and artists to produce the creative works that enrich our culture.

The scanning, uploading, and distribution of this book without permission is a theft of the author's intellectual property. If you

would like permission to use material from the book (other than for review purposes), please contact the publisher. Thank you for your support of the author's rights.

Yen On
150 West 30th Street, 19th Floor
New York, NY 10001

Visit us at yenpress.com
facebook.com/yenpress
twitter.com/yenpress
yenpress.tumblr.com
instagram.com/yenpress

First Yen On Edition: August 2020

Yen On is an imprint of Yen Press, LLC.
The Yen On name and logo are trademarks of Yen Press, LLC.

The publisher is not responsible for websites (or their content) that are not owned by the publisher

Library of Congress Cataloging-in-Publication Data

Names: Asato, Asato, author. | Shirabii, illustrator. | Lempert, Roman, translator.

Title: 86—eighty-six / Asato Asato ; illustration by Shirabii ; translation by Roman Lempert.

Other titles: 86—eighty-six. English

Description: First Yen On edition. | New York, NY : Yen On, 2019—

Identifiers: LCCN 2018058199 | ISBN 9781975303129 (v. 1 : pbk.)

| ISBN 9781975303143 (v. 2 : pbk.) | ISBN 9781975303112 (v.

3 : pbk.) | ISBN 9781975303167 (v. 4 : pbk.) | ISBN

9781975399252 (v. 5 : pbk.)

Subjects: CYAC: Science fiction.

Classification: LCC PZ7.1.A79 .A18 2019 | DDC [Fic]—dc23

LC record available at <https://lccn.loc.gov/2018058199>

ISBNs: 978-1-9753-9925-2 (paperback)

978-1-9753-1420-0 (ebook)

E3-20200714-JV-NF-ORI

Contents

[Cover](#)

[Title Page](#)

[Insert](#)

[Copyright](#)

[Epigraph](#)

[Prologue: The King of Corpses](#)

[Chapter 1: Melancholy of Monsters](#)

[Chapter 2: Citadel of the Swans](#)

[Chapter 3: Deaf to the Songbirds' Lament](#)

[Chapter 4: Ex Machina](#)

[Epilogue: Flowers Bloom Not on Snowy Fields](#)

[Afterword](#)

[Yen Newsletter](#)

May even death not do us part.

—VIKTOR IDINAROHK, *ARTIFICIAL FAIRY OUTLINE*

Federal Republic of Gjad Military
Eighty-Sixth Strike Package

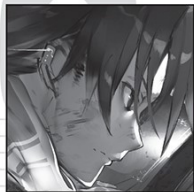

Shin

A young man marked by the Republic of San Magnolia with the stigma of being a subhuman Eighty-Six. He possesses the ability to hear the "voices" of the Legion and is a pilot of remarkable skill who has survived countless battles. He is currently the operations commander for the newly formed Eighty-Sixth Strike Package.



Lena

A Handler who once fought alongside Shin and the Eighty-Six. She has been reunited with them following their death march into Legion territory cruelly disguised as a Special Reconnaissance mission and now serves as tactical commander for the Federacy, once again fighting side by side with them.



Frederica

An orphaned daughter of the old Empire of Gjad, where the Legion were developed. She cooperates with Shin and the Eighty-Six for the sake of defeating Kiriya, her former knight and brotherly guardian, who was assimilated by the Legion. She currently serves as an assistant control aide for Lena in the Eighty-Sixth Strike Package.



Raiden

A young man of the Eighty-Six who found shelter in the Federacy along with Shin. An inseparable friend to Shin, Raiden saves him from isolation when the haunting voices of the Legion weigh upon him.



Kurena

A young woman of the Eighty-Six and an exceptionally skilled sniper. She harbors feelings for Shin, but will they ever be reciprocated...?



Theo

A young man of the Eighty-Six. A coolheaded cynic with a sharp tongue. He excels in high-mobility combat by moving about freely with the help of his wires.



Anju

A young woman of the Eighty-Six. She appears graceful but shows a much more ruthless side during battle. She specializes in suppressing fire through the use of missiles.



Grethe

Ranked colonel. She is the commanding officer for Shin and his group, and the unit commander for the Eighty-Sixth Strike Package. She developed the new type of Feldreß, the Regineif.

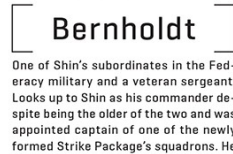

Bernholdt

One of Shin's subordinates in the Federacy military and a veteran sergeant. Looks up to Shin as his commander despite being the older of the two and was appointed captain of one of the newly formed Strike Package's squadrons. He supports Shin in battle.



Annette

A friend of Lena's and head of research and development for the Para-RAID system. She was childhood friends with Shin back when they both lived in the Republic's First Sector. She was dispatched with Lena to the Federacy and was able to finally reunite with Shin.

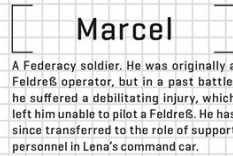

Marcel

A Federacy soldier. He was originally a Feldreß operator, but in a past battle, he suffered a debilitating injury, which left him unable to pilot a Feldreß. He has since transferred to the role of support personnel in Lena's command car.



Shiden

One of the Eighty-Six, and a subordinate of Lena's following the departure of Shin and his group. She is a valiant warrior who protected Lena and survived on the Republic's battlefield until the very end. She has since joined the Eighty-Sixth Strike Package, where she heads Lena's personal guard.

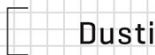

Dustin

A student who gave a speech condemning the treatment of the Eighty-Six prior to the Republic's fall. He volunteered to join the Eighty-Sixth Strike Package after Republic citizens were liberated. He is a member of Anju's unit.



Rito

A young man of the Eighty-Six who survived the Republic's fall and joined the Eighty-Sixth Strike Package. He was once a member of a squadron Shin belonged to. He has less combat experience than many other members of the Strike Package.



PROLOGUE

THE KING OF CORPSES

Arcs Styrie, capital of the United Kingdom of Roa Gracia for the past millennium. At its northernmost tip sat the royal palace, its throne room currently dim, as if to symbolize the absence of the sun's blessing upon this northern land.

However, contrary to the impression the term *northern land* may give to some, Roa Gracia was an affluent nation. Though its climate was ill-suited for cultivating grain or fruit common in the south, its lands were fertile, were graced with large rivers, and possessed rich mineral veins. A chandelier crafted from such minerals—gold and diamonds—cast a brilliant glow on the resplendent decor of the throne room. The light accentuated the shadows of the princes and princesses present.

The United Kingdom was a militaristic country, and as such, all members of the aristocracy were men and women of war. At the same time, this country was the last remaining despotic monarchy on the continent. It was a nation that still adhered to its archaic system of values.

The very personification of those beliefs, the king, began to speak from his throne. He wore a crisp military uniform, and his whitening reddish-brown hair and amethyst eyes marked him as a Viola, the race that had lived in the Kingdom since antiquity, as well as an Amethysta, one of noble birth.

His authoritative tone rolled like thunder, deep and grave, lending credence to his title as king of the frozen north.

“Viktor, my son.”

“Father.”

The one who answered him was a young prince in his late teens, standing on the stairs leading up to the throne. While normally one would kneel when in audience with the king, his royal privilege allowed him to stand upright before him. His reddish-black hair resembled the coloring of a bird of prey, and his eyes were purple lightning. While purple eyes were the key identifier of the Amethysta, his hue of violet was especially pronounced.

His hair was the dark, blackish red of eagle plumage hardy enough to withstand the unforgiving northern winter, his eyes the Imperial violet of the gemstones yielded by the Dragon Corpse mountain range, which stood as the shield of the country. His countenance was equal parts elegance and sharpness, the features of a monster made of ice.

He was the fifth prince, Viktor Idinarohk: the eighteen-year-old commander of the United Kingdom’s southern front—the front lines of the war against the Legion—and the youngest child of the current king.

“Our ally, the Federal Republic of Giad, has formed an independent detachment by the name of the Eighty-Sixth Strike Package. Do you know of them?”

“Yes, Father. They are an elite unit with the express purpose of suppressing key Legion territories and thinning their ranks. During their first battle, they struck at a Legion production site within San Magnolia and pushed back the enemy lines.”

The prince replied to the sudden question without hesitation. He’d returned from the front lines, where information was limited and scarce, only a day ago, and it was a question regarding a single unit from another country. Yet he answered as if it were simple arithmetic.

“They failed to capture a Weisel and an Admiral as they were ordered, allowed the escape of the new High-Mobility type, Phönix, and took considerable losses from the new Sheepdogs, so their first mission can be seen as a failure... But they did

accomplish their primary objective. And their dragging the two new Legion types to the fray ahead of time is a great achievement. If nothing else, it granted our country sufficient time to develop countermeasures.”

“Indeed.”

As his eyes glinted like blades, the king nodded his head, which sat atop his chiseled physique. A grave, earnest nod.

“It has been decided our United Kingdom will cooperate with that unit. The contents of said cooperation will be an exchange of technologies and dispatching of personnel... Vika—you will be joining them. Go forth and eradicate the Legion.”

“Ah yes, Father. I will be off.”

Opposite the resplendent, imposing throne sat a host of retainers.

*Could you go run a little errand for me?
Sure thing, Dad.*

It was as simple as that.

As the other princes looked on, trying to restrain their exasperation, the two continued their exchange.

“The coming operation will see the brunt of our forces on the second line, but after that we should have the leisure to dispatch forces to your aid. How many would you like?”

“I’ll be just fine with my personal unit. The Strike Package is a brigade-size force as is, and I doubt any front really has the leisure to send away any of its forces.”

Which, when simply put, translated to...

Well, while you’re at it, why don’t you use the change to treat yourself to something?

Nah, Dad, it’s fine.

This was the true, casual nature of their conversation.

The prince, incidentally, was clad not in the United Kingdom’s collared violet-and-black uniform...but in a normal black school uniform. His schoolbag sat at his feet.



He looked as if he had just returned home.

In fact, near the entrance to the audience chamber, the grand chamberlain was cradling his head in his hands after he'd frantically and fruitlessly begged the prince to at least let him put away his schoolbag.

This was not offhand negligence. This luxurious castle and its many retainers were a mere backdrop for this king and his child, the prince. There was no need to stand on ceremony or jump through hoops to appear dignified. This was a simple show of power.

The prime minister, who stood near the throne, bowed his head. He had light-purple eyes, graying hair reminiscent of fox fur, and a white beard. Despite being a Taaffe, a second-class citizen, this old retainer had climbed up the ranks with wit and intelligence and served the court since the former king's rule. He'd already grown used to the royals' insolent conduct.

"If I may speak freely, Your Majesty, Prince Viktor and his Songbirds are the crux of our national defense. Will we be able to maintain our defensive lines in his absence?"

"Refrain, minister. If my presence or lack thereof are what our ability to hold the line leans on, it would stand as evidence of negligence on the side of our men, to say nothing of yourself. I say take this opportunity to fortify yourselves."

Without even sparing him a glance, the prince cut down the prime minister's words. The old retainer smiled and bowed his head deeper. The decision to deploy forces to the Strike Package, as well as which personnel would go, had already been approved by the Imperial council. This was all to make said decisions known, as some of the princes lacked the privilege to take part in the council, and the minister's words represented the doubts they all held.

As such, this audience was done with the implicit understanding that this was the case, but there would always be those who were dense to the atmosphere. Following the minister's statement, objections rose from among the princes' and princesses' lines.

"Father! This war with the Legion is all Viktor's fault to begin with! Giving this insane Serpent of Shackles any further

responsibilities is simply—”

“Silence, Boris! Who gave you permission to speak?”

A single bellow from the throne made the third prince shrink back as if he'd been struck by lightning. The stifled chuckling of the first princess and the court warblers of her clique echoed through the room, along with the sound of the second prince—who was the third prince's de facto superior—clicking his tongue. After watching his son, his own flesh and blood, go back to the line, the king returned his gaze to his youngest child with a teasing smile.

“If one were to tally all your accomplishments up till now, not only would your right to the throne be restored, but your place in the succession order would surely rise above that of Boris.”

“I'll be just fine without that. The status would just be a pain. You can have the credit go to Brother Zafar, as always.”

Speaking in a manner that was all too unfitting in the presence of the king, without so much as a hint of reservation, the prince cast his gaze backward.

“...If that's all, can I go? I haven't been to school in a while, and I have a mountain of work to get through.”

The king smiled wryly and waved his hand, as if shooing the boy away.

“Very well... Try to finish it before supper. I long to hear your stories of the front lines.”

“By your will, Father.”

It was only now that the prince bowed in a very elegant fashion and turned to leave. His footsteps clicked loudly against the throne room's floor, which was elaborately designed with a crystalline, five-colored pattern of a butterfly's wings. The moment before he left the room, someone's voice drowned out the sound of his footsteps.

“...You damnable, doll-obsessed King of Corpses...!”

Whoever said it certainly intended for the prince to hear it, but it was still a somewhat restrained vilification. Regarding the owner of the voice with a sneer, the prince left the throne room.

When he opened the door, he was greeted by the faintly medicinal

scent of mixed black tea and his older brother's smile.

"Welcome home, Vika... Though you returned to the castle the night prior, no?"

"Ah, Brother Zafar. Yes, I arrived late, so I didn't have time to greet you."

Vika addressed his eldest brother, who was currently pouring him a cup of tea with a childish grin. It was Zafar Idinarohk—the crown prince of the United Kingdom of Roa Gracia. They were in his personal chamber, which was built of marble gorgeously inlaid with amber and was decorated with polished ebony furniture.

The brothers were quite similar, but a ten-year age gap granted Zafar's features a certain well-formed symmetry and his voice the pitch of a fine instrument. His reddish-black hair, which was now held back with a thin silk ribbon and an emerald hairpin, was the same as his younger brother's, as were his Imperial violet eyes.

Sitting down in the opposite chair as prompted, Vika watched as a chamberlain set tea snacks and sugared, boiled rose petals on the table with the acute motions of a mechanical doll. As the chamberlain left the room, Vika asked, "Is the situation really that bad?"

As Zafar observed him wordlessly, Vika shrugged and went on:

"When I'm on the front lines, I'm unable to stay abreast of every little thing that goes on in the Kingdom. Not retreating during that last large-scale offensive was honestly the most we could manage."

"Given how badly you're struggling, surely you realize the war situation's gotten critical... We have the results of the staff officers' preliminary calculations."

Elegantly lifting a silver spoonful of sugared petals to his mouth, Zafar lingered on the fragrance and refined sweetness. He then continued.

"At this rate, we won't make it to next spring."

Vika's expression did not waver in the slightest.

"So that's why they swallowed their pride and asked Giad—the country that had its land stolen by the common folk—for help. 'Technology exchange' and 'personnel dispatch' are just excuses used to sugarcoat their fragile ego," Vika scoffed. "...Trivial

rubbish. The Imperial council is nothing more than a gathering of self-aggrandizing crones.”

“What would the royalty have left if you took away their vanity, Vika? Have them dress in rags and they’ll learn soon enough that nobility and splendor are but an illusion.”

So said the crown prince. The blood running through his veins, cultivated by dozens of generations over one thousand years, boasted unparalleled beauty. The dignity with which he lifted his porcelain cup was enough to cause anyone to regard him as an aristocrat with a single glance.

Observing the younger prince, who could have been posing for a royal portrait, Zafar continued.

“As you’ve said before, the Federacy is under considerable pressure itself, even if not quite to the same extent. They’re the ones who asked for assistance with their operation, and they’re also the ones who took the bait when we proposed the technology exchange.”

The Federacy had maintained the largest territory and population since the war with the Legion had broken out, and it likely still maintained the strongest position out of all the other countries. Despite being a former world power, the United Kingdom paled in comparison when it came to land and population. And still, the United Kingdom had lost only half of the Dragon Corpse mountain range and had maintained its defensive line since, an achievement the Federacy was likely eager to learn the truth behind.

Perhaps they expected a new weapon or possibly a new kind of strategy. Whatever it was, they expected it to help defend their country. And knowing that, Zafar smiled thinly.

“Yes. Your repulsive, if lovely, little Songbirds.”

“I doubt the Federacy would make use of them if they learned how they worked... That’s probably why, isn’t it?”

Given the technology wouldn’t be of any use to the Federacy, it would hardly be missed even if the United Kingdom did hand it over. That was why that overly prideful minister of technology had okayed it. *Humans really are as sinful as can be*, Vika thought. Even in a situation where tomorrow wasn’t guaranteed, they were still absorbed in petty rivalries.

"The Federacy had other reasons to ask for cooperation. So be it...," said Zafar. "There was another condition in our agreement with them that Father didn't voice in the audience chamber. We will give that to them without fail. No complaints, I hope?"

"...The Merciless Queen."

"Come find me," it said. The message to the Strike Package officer must have held a great deal of meaning. A remonstrance for submission or some sort of negotiation. Perhaps it will try to provide some kind of information... It may sound like wishful thinking, but the chances of it wanting to end the conflict now that it has spread to its own homeland aren't exactly zero, you know."

"Yes, I suppose there's no guarantee she wasn't some eccentric Imperial, and she may have set a safety net or two in case things go awry. But that's all it is. I'm surprised the Federacy went along with it."

"So long as there is a chance Ms. Birkenbaum is involved, that's all they need to know. If nothing else, they might draw the Legion's tactical algorithm out of her... And the only remaining person capable of making such judgment calls regarding her character is, at this point, you alone."

"I haven't spoken to her that much. If anything, the Republic's researchers knew her better... Oh. But they were Eighty-Six, no? In which case, they no longer number among the living."

Vika had heard of the Republic of San Magnolia's persecution of the Eighty-Six. Surrounded by the Legion and with their backs against the wall, the Republic's Alba had chosen not to liberate themselves from the situation but instead to blind themselves to it and shift the responsibility to another party, leading to a pathetic conclusion.

"Well, come what may, I'll act as I always do," said the younger prince. "I'll trust in the decisions of Father and the Kingdom... Even if I die, in the end all you lose is another dog."

Zafar gave a slight grunt and tilted his head at Vika, who added with a shrug:

"The Eighty-Sixth Strike Package. They're all Eighty-Six, aren't they...? They may be commoners, but even the Federacy's top brass found them too much to manage. *Same as me.*"

"Vika."

"Calling them an 'elite unit' has a classy ring to it, but all they're doing is sending out these monsters they can't control to maintain the front lines, banking on them buying into their propaganda. The survival rate in dispatch operations is low. In a unit that specializes in those kinds of operations, the value of a squad member's life doesn't amount to much. Just like in the operation against the Morpho."

The child soldiers back then were Eighty-Six, too, Vika thought, narrowing his eyes. "Lives that don't amount to much"? If that's the case, in times of peace, they would amount to even less.

"If you hunt down the wolves, you rid yourself of the hounds you used to hunt them down, as well. No one needs a ferocious beast in peacetime. If the enemy and the monster you use to kill it end up finishing each other off, it saves you the trouble of dirtying your own hands putting one or the other down."

Zafar knitt his coiffed brows anxiously.

"You're no beast, Vika."

"Yes. To you and Father, perhaps."

With a grin, Vika sipped his tea. The sweet floral aroma of cornflowers blossoming in the field at the Kingdom's south wafted into his nostrils, their blooms a shade of blue nowhere to be found at this time of year.

"But can the same be said for the rest of the world? To them, I'm just like the Eighty-Six... A monster in human form."

CHAPTER 1

MELANCHOLY OF MONSTERS

Rito Oriya had joined the Spearhead squadron only last spring—two years after he had become a Processor. The first ward's first defensive line was the final disposal site where Processors who had survived too long were sent. They were sent there to die in battle. Usually, only Processors in their fourth or fifth years of service were dispatched there, so Rito's appointment after a mere two years of service had come relatively early... Or rather, it had been early until *then*.

The Republic had believed the war with the Legion would end after ten years. The Legion's life spans should have ended at that point in time. Rito and the other Eighty-Six had known that wouldn't be the case, but the white pigs had known nothing of the battlefield and wanted to quickly get rid of the livestock they'd kept for the war.

He would never forget the day the large-scale offensive had started.

Run, ya brats! I don't care if ya hide inside the walls or wherever else—just get out of here and survive!

Spurred on by the angry bellowing of the base's senior chief of maintenance, Rito and the other twenty-two surviving Processors had boarded their faithful partners—the Juggernauts—and headed south. That was just as the warning regarding the Gran Mur's fall

blared out. Just after a Handler, a slightly older girl, proclaimed the end of the Republic and the Eighty-Six.

They didn't want to die under the Republic. If they had to die, they'd rather it happened on the battlefield of the Eighty-Sixth Sector, where their countless comrades had fallen. It was this thought that led them not into the arms of the Republic but to a squadron that called for them from a fortification within the Eighty-Sixth Sector. The chief of maintenance, Lev Aldrecht, said the Handler girl was a trustworthy person and following her would increase their chances of survival, but Rito found it difficult to trust a white pig he had never met before.

Aldrecht and his crew didn't come with them.

We're the pieces of shit that had to stand by and watch you kids march to your deaths.

For some reason, Aldrecht and the other maintenance crew all smirked when they said that. Judging by the looks on their faces, they seemed oddly relieved. The Eighty-Sixth Sector's maintenance crew consisted of Eighty-Six who were formerly Republic soldiers and the surviving adults who'd enlisted early on in the war. Servicing the Juggernauts required considerable skill and technical know-how, and since they had that knowledge, they were spared from being eliminated after they'd been injured in combat, and they were allowed to keep working. They were Eighty-Six whose lives happened to have slightly more value than most.

That was why they'd had to watch as these child soldiers, whose lives had little to no value in comparison, had marched to their deaths over the last decade... Aldrecht and his crew likely cursing their powerlessness and uselessness from the bottom of their hearts all the while.

So sticking around here and letting the heaps of scrap metal butcher us is fitting punishment, y'see...? We got nowhere else to go but here.

They would finally be set free from that guilt. They would finally atone for the sins of leaving others to die... So told the smiles on their faces as they shouldered old assault rifles, all-purpose machine guns, and rocket launchers they'd hidden God knows where.

As the Eighty-Six fled, they heard the sound of those weapons firing from the direction of the base. Those weapons were weak, even compared to the Juggernaut, and didn't serve as a means of countering the Legion. The all-too-familiar sound of a Löwe's 120 mm turret thundered across the landscape, and the Ameise's antipersonnel machine-gun fire reached their ears. And then the base fell into eternal silence.

When they reached the defensive base near the southern front, the southern front's first ward's first defensive unit, Razor Edge, served as the main force. It was the first time Rito ever saw so many forces in one place, but their numbers rapidly decreased in the blink of an eye.

The conflict was already well underway by the time aid arrived. A force of units consisting of polypedal weapons and armored infantry crossed the Legion's territories from their neighboring country, Giad. They were pearlescent Feldreß he'd never seen before, yet somehow, they seemed oddly familiar. Looking back, he realized one of those Reginleifs may very well have been Shin's.

"...Cap'n Nouzen."

The boy who'd served as captain of the first squadron Rito had been assigned to. A boy who was three years his elder but four years his senior in terms of battle experience. After six months in that squadron, Shin had ended his term, and it had been decided he'd be sent to the Spearhead squadron... And Rito had then assumed he'd probably died, either in combat or in the Special Reconnaissance mission.

Rito told Shin that Aldrecht had died, but he didn't tell him of his final moments nor his last words. He thought...Shin was *saddened* by it. Shin, who took on the role of the Reaper, who carried on the names and memories of those who fought by his side, perhaps wanted to take that obstinate old chief of maintenance with him in some form.

But he couldn't understand.

The highest rate of casualties among Processors occurred either at their final disposal site or when they were novices at the start of their service—when they knew nothing of the battlefield, any potential they may have was still untapped, and they could

die at the slightest stroke of bad luck. Rito spent his first six months, the period when most novices died, in a squadron of Name Bearers like Shin and Raiden. It was a squadron of veterans, so it had few casualties in comparison to others in the Eighty-Sixth Sector...

He'd grown used to battle without having to see the comrades at his side blown to bits, and he'd had a chance to learn how to fight and survive. And by the time Rito and his comrades left, he'd gained the skill needed to defend his comrades in battle, if only somewhat.

And so Rito wasn't used to it yet. To the terror... Shin, who had bathed in it so much he'd gained the title of Reaper, would probably never understand.

Looking out the train window, all Rito could see was pitch-blackness. Sitting on this train, riding to their next battlefield, Rito gazed at his own reflection in the dark window and whispered to himself in a somber tone so as not to awaken his friends sleeping next to him. In a voice that wouldn't reach the Reaper, whose ears could pick up even the voices of ghosts.

"Cap'n. To tell the truth, I'm still...still afraid to die. And I'm still afraid of seeing others die, too."

A deafening howl, like a beast that had had its throat crushed, echoed loudly from the other side of the window. It was the sound of the high-speed train running along the track that reverberated through the tight pitch-black tunnel. It echoed, dredging up a particularly foul mood in Shin and making him recall things he would have preferred remain buried. As he was forced to play audience to the incessant continuo alternating between a high pitch and a low one, Shin traced back memories that teetered on the edge of oblivion.

They were on the western intercountry high-speed railway, namely on the Eaglefrost route, currently passing through the Dragon Corpse tunnel. A line that once connected the former Empire of Giad and the United Kingdom had been partially reinstated and recently opened for military use. The Dragon Corpse tunnel had been built along this line, making it the longest

railway tunnel in the world.

The Legion made use of everything they could find in the land they stole from humankind to benefit their operations, but the same held true for humankind. The Legion had maintained the old high-speed railway lines to allow for the Morpho's movement, and now that the Highway Corridor had been retaken and was back in human hands, they'd begun restoring it for military use.

The officers' passenger car consisted of rows of box seats opposite each other on both sides. Those sitting in them were mostly dressed in the steel-blue colors of the Federacy's military, but some Eighty-Six soldiers were there, too, adding other hues into the mix.

Shin's eyes narrowed, and a small sigh escaped his lips as he turned his gaze to the dark window. Eleven years ago, during the convoy to the internment camps, he'd heard the same sound from behind the walls of the freight car. They'd been stuffed into a freight train made for delivering livestock, and it had been so cramped that there had been no room to move.

It was entirely different from back then, though, when the body heat of so many people in close quarters, combined with the lack of ventilation, had made it hard to breathe. Remembering it filled his heart with an odd sense of discomfort. He'd suddenly been subjected to jeers and spite and shipped off to a strange place. And yet, he couldn't remember the expressions his parents or his brother—his stalwart shield—had often worn. At the time, Shin had been small for his age, and the constant confusion and terror of that period now bubbled to the forefront of his mind.

It's not that you can't remember your childhood. You don't want to remember it.

A voice like a silver bell surfaced in his memory, making him narrow his eyes inadvertently.

Because that way you can keep thinking that the things you lost, that were taken from you, never existed to begin with.

That way you can keep believing people are despicable.

...That's not it. It's not that I don't want to remember or anything. Still, the fact that I can't remember doesn't inconvenience me in any way.

“—Shin.”

Turning in the direction of the voice, his gaze fell on the opposite seat, where Raiden was sitting.

"We're almost to Rogvolod City. They said it's a lot colder there than in the Federacy, so remember to put your coat on before you get off."

"Right."

The train could run only until the terminal just outside the tunnel. After that, the railway's gauge had to be switched. The train ferried several thousand troops and Juggernauts that weighed roughly ten tons each. Reshipping would take a considerable amount of time.

The railroad allowed for large-scale, high-speed transportation, enabling it to move far more troops and equipment than the standard quota. So even if the Federacy had been a friendly nation in ages past, and even if it was an ally of the United Kingdom in the war against the Legion, allowing a large number of weapons and troops to directly enter the capital—the veritable jugular of the country—wasn't something the northern country looked upon with fondness.

"But man, the United Kingdom, huh...? It's like, heh, we really did go farther than we ever expected to go, didn't we?"

"...For sure."

Two years ago, none of them could have ever imagined leaving the Eighty-Sixth Sector. The train they were on now crossed the Federacy's northern border and was following the tunnel cutting through the Dragon Corpse mountain range, heading to a neighboring country they'd never known.

The United Kingdom of Roa Gracia. A land of weaponry, oil production, and gold mining. The *Empire* of Giad's sole ally and, at the same time, its constant hypothetical enemy. With the Empire's fall, it was now the sole remaining despotic monarchy on the continent.

And the Eighty-Sixth Strike Package's next battlefield.

"—Our upcoming operation's primary objective is the capture of the commander unit located in the United Kingdom's southern front, identifier: the Merciless Queen."

While they were officers just like the Processors, the field officers Lena, Grethe, and Annette were allotted a separate car. It was done to maintain the superior officers' authority, as well as to ensure secrecy. Information in the military was disclosed on a need-to-know basis, and there was a significant gap between the amounts of information a commanding officer and a Processor were privy to.

Their first-class passenger car was lined with amber-colored wooden panels, and as they were seated around the parquet table over cups of steaming tea, Lena nodded.

"The message from the Legion that Captain Nouzen witnessed during the Charité underground-terminal operation—it was a clue that would supposedly lead to the commander unit, correct?"

It was also the only remaining Ameise unit manufactured in the lifetime of Major Zelene Birkenbaum, the Legion's creator and a researcher from the former Empire of Giad. Zelene's personnel file hadn't been lost during the upheaval of the revolution, so her head shot remained. The information-analysis team shared the photograph with the only person who had witnessed the message, Shin, who said he thought it matched the face he'd seen.

Come find me.

Words that were all too inexplicable for humankind, coming from the Legion that took no prisoners nor attempted any negotiation during their one-sided war for a country that didn't exist anymore. Perhaps Shin, whose appearance greatly implied his Imperial noble descent, was one of the triggers. The Legion were currently an uncontrollable autonomous system, but they weren't in a berserk state. The ones who'd given them orders were long gone. They continued to fight because it was the final order they'd received. Even now, the Legion were obeying the last will and testament of their ruined nation.

If that was the case, perhaps the Legion had judged this situation of not receiving new orders for so many years to be unusual and had begun seeking a new master to lead them.

"It's believed any new information we gain by capturing it might be a hint toward ending the war."

Even if Zelene had no such intent, she was still responsible for

the Legion's development. It was possible that she possessed an emergency shutdown code or some kind of administrator password.

"Yes. The United Kingdom has agreed to hand her over in exchange for their presence in all investigations and disclosure of all information we come up with, so after you seize or incapacitate the Ameise, please bring Zelene back home to us. We don't mind what condition she's in, so long as her central processor remains intact."

Annette tilted her head.

"I'm surprised the United Kingdom accepted those terms. They're a despotic monarchy, so from their perspective, the Republic and Federacy citizens are just commoners. I figured they'd be a little more condescending and give us a hard time."

"It just means they don't have the leisure to do that any longer. This expedition's objective is a tech exchange with them, of course, but it's effectively an aid effort from the Federacy to the United Kingdom."

"But is that really true? The United Kingdom and its Owl King have been feared since before the war with the Legion began, and now they're on the brink of collapse...?"

The United Kingdom of Roa Gracia was currently the second-strongest surviving country, after the Federal Republic of Giad. While the Federacy dwarfed the United Kingdom in population and sheer territory size, the United Kingdom had the martial strength to withstand the large-scale offensive and send forces to assist with the Morpho's subjugation operation.

Why would such a powerful country do this now, all of a sudden?

"The answer is simpler than you'd think. Now that the Sheepdogs make up the bulk of the enemy's forces, the fighting becomes that much more challenging on every front in every country."

Lena grimaced in realization as Grethe took a sip of her coffee substitute. The Sheepdogs. The mass-produced intelligent Legion created by using Republic citizens captured in the large-scale offensive. It appeared they had transferred the data to their military kernel before they abandoned the production site during

the underground-terminal operation.

Ever since that operation, the Legion's strategies had become more elaborate. It seemed the replacement of the Black Sheep—Legion that assimilated the damaged neural networks of the dead—with the Sheepdogs was progressing.

"As planned, Major Penrose and I will be in charge of the technology exchange. Colonel Milizé, you will be in charge of command on the front lines. Part of the United Kingdom's unit is set to join the Strike Package upon completion of this operation, so become familiar with their forces as soon as you can."

Grethe said this with a grin.

"We'll be mobilizing all four thousand of our number for this mission. It's time for the Eighty-Sixth Strike Package to show off what it can really do."

Annette tilted her head.

"There were a lot of people who didn't volunteer, too. I hear around ten thousand surviving Eighty-Six were taken in and sheltered by the Federacy."

The Eighty-Six were treated as special officers who received a higher education during their service in the Federacy military. Having been sent to internment camps since their early childhood, they'd never even received an elementary education. As such, their term of education was longer than a regular special officer's, and while some studied through correspondence, their tutoring was moved to a special school set up near their headquarters' base.

With their scheduled leaves taken into consideration, a quarter of the troops at a time alternated between schooling and training, so the largest number of troops the Strike Package could deploy at any given time was four thousand.

Incidentally, the ones who studied from afar using correspondence were Shin and his group, the first to be sheltered by the Federacy. Following the large-scale offensive and the establishing of the Strike Package, they were too occupied with their duties and ended up neglecting their schoolwork. But even if one were to assume that only half of the ten thousand troops rescued were active forces, the math still didn't align with the fact that they had only four thousand troops.

“Former maintenance crew members became Reginleif mechanics... Some of those children can’t fight. Some fought too much. Others lost the will to fight.”

The number didn’t include children who’d been sent to the internment camps at an extremely young age, those who’d developed mental health issues, and those who simply didn’t want to be drafted.

“And how are those kids...er...being treated?”

It seemed the Federacy had its own share of problems, what with large amounts of invalids and war orphans who had appeared over the ten years since the Legion War had started.

“They were either sent to specialized institutions or taken in by guardians... The Eighty-Six are treated like Captain Nouzen and his group; they’re adopted on paper by former nobles and high officials. Most of them are only lending their names, but they can’t treat them too carelessly. Their names are quite literally on the line here.”

It had been only ten years since Giad had transitioned from an Imperial government to a democracy, but the ethos of noblesse oblige—which included acts of philanthropy—still held strong. Perhaps now that the class system had officially been abolished, that was the only means the former nobility had left to set themselves apart from the masses. Lena sighed in relief.

“I see. That’s...good, then.”

“Between that and the cooperation with the United Kingdom, there are times when the nobles’ obsession with maintaining their honor and dignity can come in handy.”

The United Kingdom’s sending of forces after the conclusion of the joint operation was also thanks to this idea of noblesse oblige. One of its commanding officers was to join them as a guest officer under Lena’s direct command. As such, he’d be demoted to lieutenant colonel so as not to clash with Lena’s rank of colonel.

“I hear the United Kingdom officer is royalty.”

“Yes, the fifth prince, Viktor Idinarohk. Despite being only eighteen years old, he’s an influential figure who serves as the southern front’s military commander. He’s also a deputy secretary of the royal technological institute and this generation’s Espers.”

Grethe mentioned it casually, but for Lena, who grew up in the

Republic, the word *Esper* still had an esoteric ring to it. On rare occasion, members of a particularly archaic bloodline exhibited these supernatural abilities, and Giad, which had been ruled by royalty until eleven years ago, still retained several of those families. Some Espers would enlist in the military, acting as specialists who performed as well as, if not better than, modern equipment.

The Republic, on the other hand, did away with Espers three hundred years ago, when it abolished the class system. In order to avoid mixed blood and perform consanguineous marriages without adverse effects, a clan required a large number of family members, as well as assets to support them. And the old nobles, who had lost their assets and land to the revolution, couldn't maintain those conditions.

The Strike Package included two Espers already, namely Shin and Frederica. But from Lena's perspective and that of common sense, something about those extrasensory abilities felt terribly unnatural. And after the last operation, Shin's ability caused his physical condition to deteriorate significantly.

This wasn't something normal, of course, but resulted from the strain caused by the introduction of the Sheepdogs. But if his ability burdened him so much, Lena honestly couldn't bring herself to believe it was something he should employ as a matter of course... And Grethe had described the United Kingdom's Esper as "this generation's Esper"... If that implied many couldn't exist in the same generation, it may well have meant these abilities had enough of an adverse effect on one's health to cut down their life span...

"...Hmm, what kind of special ability does the royal family have?"

"Prince Viktor single-handedly developed the Legion's artificial intelligence model, the Mariana Model, but maybe saying that he developed it when he was only five years old will put things into perspective. Theirs is a bloodline that produces geniuses and prodigies. He also has the impressive achievement of developing and improving the United Kingdom's Feldreiß control system... On the other hand, he's infamously known as the King of Corpses and the Serpent of Shackles and Decay—the viper. There are also

rumors that his right to claim the throne has been revoked.”

Annette repeated her words in shock.

“R-revoked?! He didn’t relinquish it? It was revoked...?”

“And ‘Serpent of Shackles and Decay’...? That’s awful...!”

In the cultural sphere of the continent’s west, snakes were a symbol of corruption and the devil. Especially the viper, which had potent venom capable of melting away one’s flesh and curdling their blood. It was not a name one would lovingly give their prince.

“Despite that, the authorities he’s been given are many and significant, and the crown prince, who shares the same mother as Prince Viktor, seems to cherish him... There’s a struggle over the succession rights of the United Kingdom between the crown prince and the second prince and first princess, who are children of concubines. Prince Viktor is part of the crown prince Zafar’s faction. He’s lauded as the right-hand man of the capable, renowned crown prince.”

“...Where did you get all this information...?”

Grethe shrugged casually.

“We reopened this railway the winter before you arrived, and some members of the United Kingdom military, a small number of soldiers, have been coming and going ever since.”

“...Right.”

“So at that time, the information bureau sent people over to their side or perhaps restored contact with people who were there to begin with... I suspect the same holds true *for both sides* here.”

The former Giadian Empire and the United Kingdom of Roa Gracia had been despotic monarchies and old allies, but at the same time, they’d served as hypothetical enemies of each other. And that hadn’t changed even now that the Empire had fallen and humanity had gone to war with the Legion...

“By the way, Colonel Milizé.”

Grethe spoke with the same casual tone one might use when mentioning the weather, so Lena was caught unprepared. Annette, who did pick up on what was coming, stealthily left her seat.

“Did you have a fight with Captain Nouzen?”

Lena choked on her tea.

"Huhhh...?!"

"I haven't seen the two of you speak ever since you returned from the Republic."

"Er, that's..."

Lena turned to Annette in a pleading manner, but Annette avoided her gaze.

"I'm not touching this."

"I didn't intend to involve myself in your private affairs, but this has been going on for far too long. If our tactical commander and the captain of our armored units have communication issues, it could impact future operations."

"Right..."

It's been like this ever since then.

"You're still trapped by the Republic. By us—the white pigs."

"That makes me...so sad."

Since she'd said that, she hadn't had a proper conversation with Shin. It wasn't that they were avoiding each other. They had exchanges that pertained to their duties, but they couldn't hold a conversation about anything else. So all the trifling topics they'd talk about when they finished their reports and business talks or whenever they passed each other in the hallway simply stopped happening. All that remained was strained silence, and the awkwardness of it all stymied their conversations.

That situation had lasted for a while now. She didn't regret anything she had said back then, but she now realized that it had been wrong of her to one-sidedly make assumptions. At the time...when she said it, Shin had seemed to be enraged momentarily but had restrained himself. Still, there had been a hint of annoyance in his voice when he spat out:

"I don't...understand."

And there had been reservation mixed in his tone as well, along with...

"Is that really so bad, Lena?"

...confusion. Complete and utter confusion.

He couldn't understand what Lena was so apprehensive about or what had made her sad to begin with. His eyes showed he couldn't comprehend it whatsoever. As if none of her words, none of her emotions ever got through to him. As if he were an

innocent, warped monster that resembled a human in shape alone.

Her sudden confession had likely confused him. It felt as if this was how she wanted him to be.

But I'm completely different from them. And I didn't want to have to think that we might speak the same language, see the same world, exist in the same place, yet never see eye to eye.

No.

It's more than that.

At the time, his crimson gaze had held a mixture of indignation and confusion—and behind it was the wavering light of a wounded child. She was sure of it. As if he'd been struck by someone he'd never imagined would lash out at him. As if he'd never expected Lena to say that to him.

Fighting to the bitter end and moving on to their final destination was the Eighty-Six's pride and freedom. Lena had heard it before. From them. And to live up to those words, they stepped back into the fray even after they'd been rescued by the Federacy. So to tell them that they were still trapped...that they were still in the Eighty-Sixth Sector, that they hadn't moved a single step forward from where they once were, was an insult beyond description.

Under the pretense of grief, she'd trampled over the only sense of pride they were allowed to have.

She didn't want to think she might have been the one to hurt them this way... And the moment she had, Lena had been assailed by a self-hatred that felt like drowning in a sea of flames. In other words, she'd been the one avoiding Shin. Running from the fact that she'd insulted him... From the fact that she'd hurt him.

"...Colonel?"

It had been the same two years ago. She'd thought she was standing by their side, that she understood them. But the truth was she hadn't really tried to learn anything about them, not even their names. She'd just one-sidedly forced her feelings and impressions on them and, in so doing, hurt them.

"Colonel Milizé."

Nothing's changed. I've learned nothing after all this time. How disgraceful. How embarrassing.

"Colonel, I'm talking to you."

...Wait, no. What am I going to do if he hates me for this...?!

"Hey, cut it out, Lena. Just calm down."

Lifting her face with a start, she found Grethe and Annette staring at her. Lena then realized she'd cradled her head and sagged against the table without noticing.

Grethe flashed a grin.

"...Looks like it's more severe than I thought."

"I-I'm sorry..."

"Well, you've only just met him. The occasional disagreement or argument is par for the course."

Grethe's ruby lips curled upward once more.

"Captain Nouzen won't be stopping at the base our unit will be stationed in. He'll be coming with us to the royal capital. You'll have plenty of time to talk until the operation. Use that time to patch things up."

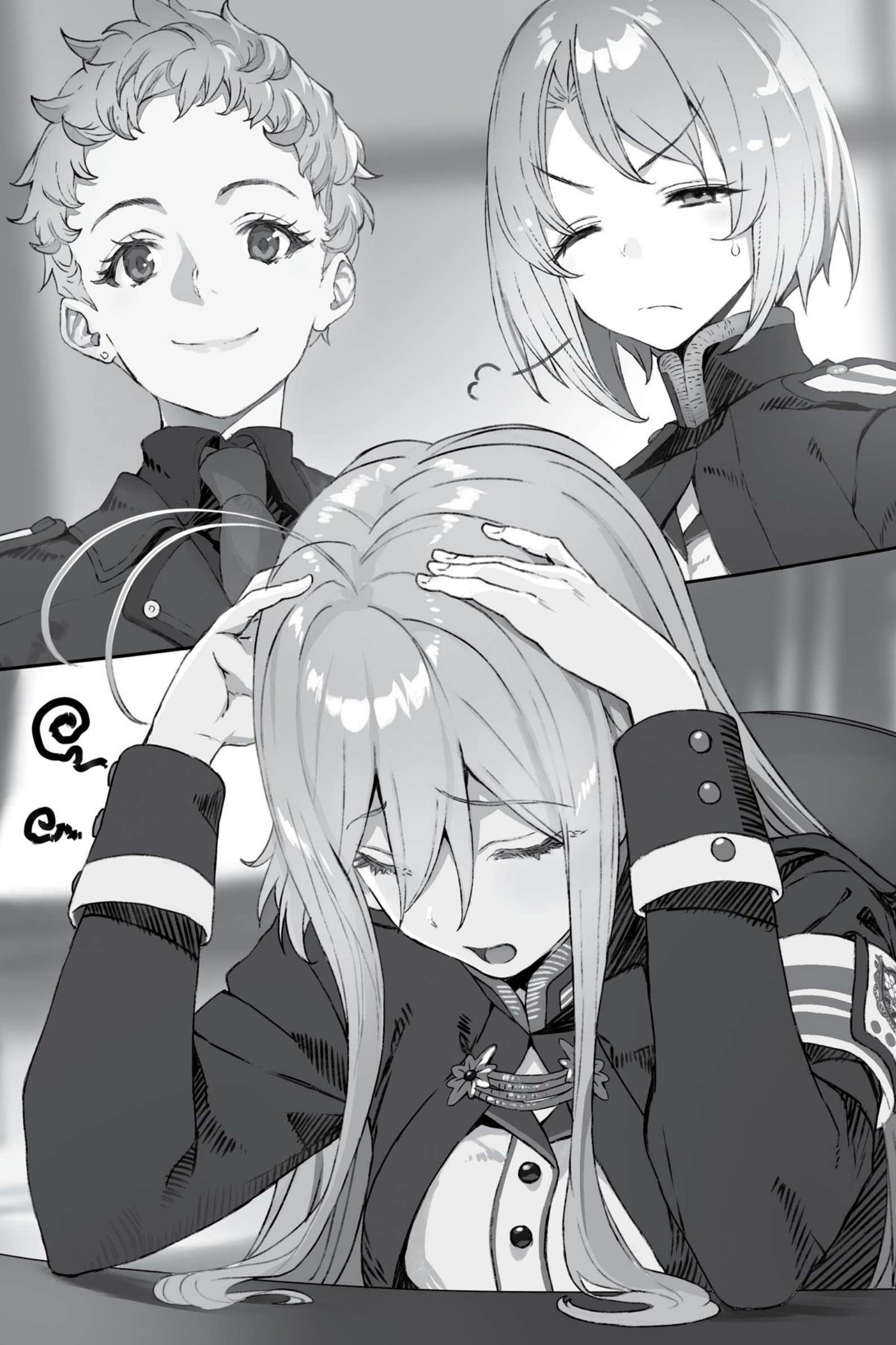

* * *

"...By the way..."

With his eyes still turned to the darkened train window despite not really looking at it, Shin tensed up when he heard Raiden's voice.

"Did you have a fight with Lena or something?"

He'd already lost the moment he'd looked back at him reflexively. Raiden leaned his elbow against the window and pressed his cheek against his fist as Shin raised an eyebrow.

"...How?"

"Whaddaya mean, how...? You were trying to hide it? Hell, man, you really have no self-awareness whatsoever, do you?"

Hearing Raiden's incredulous voice was surprisingly irritating. Shin sighed, breaking the inadvertent glare he'd shot into Raiden's reddish-brown eyes, and shifted his gaze back to the blackened window.

"...I don't think it was really much of a fight."

Shin couldn't call it a fight, given his all-too-vast experience with fights to the death and the terribly hateful treatment those descended from the Empire's bloodlines sometimes received. Compared to that, a simple difference in opinions didn't even register as a dispute.

Or rather, it shouldn't have, but...

"She said we...the Eighty-Six, are still trapped in the Eighty-Sixth Sector."

Raiden fell into a momentary silence.

"...Did she, now?"

He squinted but suppressed whatever emotion made him do so, probably because Lena was the one who'd said it. And she certainly hadn't said it out of spite. But they still annoyed him, which was an emotion Shin knew all too well.

"That makes me...so sad."

The moment he'd heard those words, something had instinctively spurred him to recoil. But what had sprung up alongside that emotion was confusion and just the slightest tinge

of pain. His not being able to understand what Lena was so apprehensive about was part of it, of course, but what confused him the most was that he didn't understand why he felt the need to argue.

Was it because if he did, he could continue believing people were despicable...? Was it so he wouldn't give up on this world, cold and cruel as it was?

But that's *exactly* the way things were.

That was just how the world worked. It didn't revolve around humankind; it was indifferent and cold—and helplessly so. And that applied all the more for human beings, who, unlike the world, acted on the malice they felt for others. That was something Shin had learned all too well in the internment camps and on the battlefield of the Eighty-Sixth Sector. Seeing it repeat itself time after time gave him all the lessons he would ever need.

So he'd simply pointed that out... What was unpleasant about that? He'd merely stated the facts. Was it because she was saddened? Because she pitied him? As Grethe once said, no one had the right to pity them. But at this point, Shin honestly couldn't care about that anymore. The other party was free to pity them all they wanted, but Shin had no intent of playing along.

But if so...why?

Shin didn't really understand what Lena was sad about. He had no desire to sadden her, of course, but since he couldn't understand, he didn't know how to handle it. It was hard not to feel as if she was avoiding him, and in truth, they had hardly spoken since. In the end, neither of them was willing to broach the subject, leaving things in a state of awkward silence.

"—Shin. Yo, Shin."

Before he'd noticed, Raiden was waving a hand in front of his face. Shin seemed to have gotten lost in his thoughts for a good while. He looked back at Raiden, who smirked.

"Y'know, you really...really have changed."

"?"

"Forget it," Raiden replied, exasperated. "Well, knowing you, you'll end up trashing Undertaker soon enough, so talk to her then... I mean, your rig's one hell of a Hangar Queen."

That was slang for a unit that always broke down and spent

more time being repaired in the hangar than out on the battlefield. Small skirmishes aside, Undertaker had a way of always taking severe damage during large battles, so perhaps it was only natural it would end up being called that.

"...Old Aldrecht always gave me shit for that..."

"Yeah..."

I ain't telling you to apologize—I'm telling you to change yer ways!

That crazy fightin' style of yours is gonna get ya killed one day!

Rito had told them he'd died during the large-scale offensive, along with the other maintenance crew members. All of them, on the same day. Shin had felt a tinge of emotion upon hearing that, but some part of him had known that might be the case. The Eighty-Six made the battlefield their home and prided themselves on fighting to the bitter end. And all Eighty-Six eventually died. And that held just as true for the old head of maintenance, who'd stood by their side despite being an Alba.

But still...

"...I kinda wish he survived."

Raiden turned his eyes to Shin, who continued without meeting his gaze.

"If he could've survived until the rescue forces came, he might've at least been able to see his family's pictures. Looking for their remains would have been difficult, but he would've been able to go to their last battlefield."

Unlike me, who can't remember my family... Aldrecht, who still remembered his wife and daughter, could have had that little bit of peace.

All Eighty-Six died eventually... Shin understood that. But that didn't mean he was completely unmoved by the sheer amount of death he'd witnessed.

"...True, once the war with the Legion ends, visiting graves like that will be a possibility."

After a heavy sigh, Raiden leaned forward.

"What do you think, Shin? Did the 'Zelene' you saw look like she was down to end the war?"

"...Who knows?"

That woman-shaped cluster of Liquid Micromachines hadn't

possessed a feature to emit sound, so Shin had had no way of picking up any emotion or nuance in her tone. All he could glean was the message.

Come find me.

There was no way of knowing what the intent was. Even for Shin, the person to whom those words were directed.

"It's one thing to assume they want to negotiate or exchange information, but hoping something like that was a hint for ending the war feels like a leap of logic to me. Even if there is information the United Kingdom is holding back from us...I don't see this war ending so easily."

There wasn't a single place on the continent where one could escape the war, and they couldn't remember a time when that wasn't the case. However...

"...But if the war ended...I think that'd be a good thing, in its own way."

I want to show her the sea.

Things she didn't know, things she'd never seen before. He wanted to show her everything the Legion had stolen from the world. Shin hadn't forgotten those words. This was a worthy reason to fight. He didn't have any expectations... That wish would likely go ungranted. But someday, if the war ended...

Raiden fell silent for a moment.

"Yeah. If the war ended..."

His sentence cut off halfway through, and he didn't say any more. His silence spoke volumes, and Shin understood.

It would be nice if the war could end, they felt. But it was still impossible to imagine—because all they'd ever known was the battlefield.

There was a loud groan, and then their car was suddenly filled with light. In less than twenty minutes, the rolling stock of the high-speed train had traversed the tunnel that had taken two years to excavate. Their corneas, which had gotten accustomed to the dark, were momentarily blinded by the sunlight but gradually grew used to the glaring whiteness that filled the scenery outside the train.

The two wordlessly looked out the window. The bulletproof glass of the windowpanes impeded their visibility somewhat,

giving the view outside a bluish tint. It was a different country, but the dreariness of it all remained the same. No combatants lived near the fronts. Any that survived left their homelands behind.

Thick silver-gray flakes fluttered to the ground. Old ruins dotted the snowy fields, making the view appear almost as desolate as the Eighty-Sixth Sector's battlefield; everything looked to have frozen over, and the wasteland stretched on as far as the eye could see.

The United Kingdom of Roa Gracia's Rogvolod City Terminal.

"We'll be heading to the base first, then. It's the, uh, Revich Citadel Base, right?"

"Yeah... Sorry for dropping all the dirty work on you."

"Well, you technically are my superior officer, and the staff officers and majors will be taking care of the transfer itself. You guys just take care of escorting the colonel and Lena."

Waving his hand, Theo made his way to his next train as the container for the Juggernauts was being unloaded and reloaded. Half the unit would go today, and the other half would go on the next transport. The Strike Package's thousands of troops and their Feldreiß would be moved to the Revich Citadel Base, on the United Kingdom's front lines. They were making the transport in stages and with breaks in order to slip under the watchful eye of the Observation Control type, the Rabe.

After seeing his comrades off, Shin turned around to look at Rogvolod City. As he'd been told on the train, this city, which lay at the feet of the Dragon Corpse mountain range, was covered in cold, light snow. It was the southernmost city populated by civilians and was currently under blackout, which spoke to how frugal they had to be with electricity.

A short distance away from the city area, sitting in the shadow of a massive, rectangular domed structure lit by starlight, was the nuclear power plant that provided the district with heat.

Suddenly he heard the sound of someone stomping through the snow behind him.

"...Nouzen."

Turning to find the owner of the voice, Shin saw a young man with a medal bearing a vehicle on his chest. He was one of the controllers who served in Lena's command car, Vanadis, and a contemporary of his from the special officer academy: Erwin Marcel.

"Didn't you retire from the military?"

"I can't pilot a Vánagandr anyway. My leg got messed up during the large-scale offensive."

Judging from the sound of his footsteps as he approached, the injury didn't impede his walking, but Marcel looked down at his right leg as he spoke, saying that it was a compound fracture... When his broken bone had sliced through his flesh and skin, it had also severed a nerve. It didn't hinder his day-to-day life, but the injury was devastating enough that he was no longer capable of the reaction speed needed for the split-second decision-making it took to pilot a Feldreiß.

"Besides, the hell do you mean, 'Didn't you retire'? Unlike you Eighty-Six, we special officers can't put food on the table if we quit the army."

"You were gone from the register of the 177th Armored Division's unit after the reorganization, but your name wasn't announced on the war-dead broadcast. So I figured you retired... Didn't think I'd see your name on the Strike Package's command car unit register."

"...Didn't think you cared. I always figured you didn't give two shits about anyone and anything around you."

That lack of emotion and interest was something he'd hated about Shin since the special officer academy, Marcel thought. The way he was so detached from the hell of the battlefield... The way he could see through the terror in other people's hearts felt almost as if he was mocking them in some way.

"...About Nina."

Shin narrowed his eyes at the sudden mention of that name. Eugene had been a common friend and contemporary of theirs, and Nina was his younger sister. Shin had long since torn up and thrown away the letter she'd sent him, demanding to know why he'd killed her brother.

"I shouldn't have told her how Eugene died... That letter wasn't

something a person needed to receive right before an operation they could've died in. I should've just told her that Eugene died and it was tragic and left it at that, but I ended up saying too much. I wanted her to think his death was someone's fault, and I pinned it on you... I'm sorry."

He lowered his head deeply. Shin simply shook his head and asked, "How's she doing?"

After she'd lost the parents she couldn't remember, the one person she'd had left—her brother—had died, too.

"Right... Well, she's doing okay... With everything that went on with the Republic, the Alba back home are kind of ashamed. But, you know, her brother was a soldier, so she doesn't get harassed, and she isn't hung up on Eugene's death, either."

Shin closed his eyes.

She isn't hung up on it. She isn't waiting for her brother, knowing he'll never return.

"That's...good, then."

Marcel's face lit up with surprise before his expression shifted into a light smile.

"...Right."

After Marcel walked away, Frederica, who had watched the exchange until now, walked up to Shin.

"...Are you really fine with that? That man... Well..."

"I don't care... Not at this point."

She looked up at him with her eyes oddly half-open, shrugged, and craned her neck, causing her small head to droop. The only ones heading for the capital, Arcs Styrie, were the brigade commander, Grethe; the tactical commander, Lena; Annette; a few select technical officers; and the senior squadron commanders and their vice captains: Shin and Raiden, and Shiden and Shana.

"It feels silly asking at this point, but is it all right for you to come with us to the capital?"

Her even just being implicated in an operation in which soldiers from another country were involved was problematic. She was an empress, if only a former one who was just a baby when the war started and who hadn't been formally coronated. Since her ability was passed down through her bloodline, Shin didn't think it would

be safe to have someone from outside the country see her. He'd started the conversation now because there was no concern of someone eavesdropping on them here.

"My presence serves as the answer, does it not?" she said, as if without any intent to put on airs. "Members of the Giad Imperial household have been puppets for the great nobles for two centuries. Since the dawn of the Empire, the royal family has been forced to mix its blood with that of different races that entered the country. The lower nobles never knew the emperor's face, to say nothing of the commoners, and have grown to believe the Imperial house's abilities have diminished as repeated mixed marriages thinned our blood. Even the Idinarohks' Amethystus would be hard pressed to learn that I am the empress Augusta...

"*Amethystus* was a term used to describe the Idinarohk line's Espers for generations," she added. Theirs was a bloodline that produced geniuses capable of feats like developing new AI models each generation.

"However, I do believe some of the western front's generals harbor suspicions of my survival... Otherwise the record of your exchange with Milizé following Kiriya's destruction would not have been played as it was before the generals."

Shin grimaced because he'd been forced to be present in the briefing when the recording was played before the generals, a time that he could only compare to torture. It was a memory he didn't want to relive, so he'd kept it out of his mind until this moment. Even if the mission recorder had mostly picked up audio that had gone through the Processor's intercom and exchanges with the outside, it was unlikely that it hadn't picked up the voice of Frederica—who'd been in the cockpit with him—at all.

Right. At the time, Ernst had *called her Frederica*.

"So since he knows, there's no danger of him betraying you?"

"On the contrary..."

Frederica tilted her head lightly. Almost sorrowfully... Apprehensively.

"I'm sure you've suspected it... But that man is a fire-breathing dragon. He puts ideals before all else and would cast himself and the rest of the world into the flames for the sake of upholding them—with an obsession and fixation that cannot be restrained.

Honestly, that man is such a dragon.”

“...”

There was an expression that sometimes surfaced on the face of the man who was technically his adoptive father that contrasted with his usual amicable gaze. Words that were equal parts sympathetic and hollow, with only a thin veneer of sincerity on the surface. At times, Shin noticed the subtle cruelty behind his words.

If that's what humankind has to do to survive, then we deserve to be wiped out.

“If I were to be set up as a symbol to capsize the Federacy... If humankind was foolish enough to put the Federacy and the rest of the world in danger before the conclusion of the war with the Legion, over pointless greed...he would likely think we were all better off going extinct.”



A change to democracy meant the transition and redistribution of wealth. Properties and commodities that once belonged exclusively to the royalty, who made up only a small percentage of the population, were distributed among the populace. That led to an increase in the standard of living for the vast majority of people. But it also meant that extravagant, gaudy luxury items gradually started to disappear.

However, in the United Kingdom of Roa Gracia, which had been a powerful country for generations and was now the only remaining despotic monarchy, the royalty still held its wealth. In fact, Roa Gracia was the only nation that still produced such luxury items. The royal castle, which stood as the symbol and temple of the royals, was so dauntingly glamorous that it left Lena feeling overwhelmed.

The room they'd been taken to looked as if it had been made to entertain guests, not conduct official business. Laburnum and rose vines dangled down from the ceiling, along with a crystal chandelier in the shape of a blue passionflower, and the polished agate floor shone as if a mirror had been spread out below them.

The furniture was all uniformly made of ebony inlaid with malachite, and a large number of roses—which were particularly rare in the frigid north—sat in aventurine vases.

At the corner of the room were a shining glasswork model of a peacock, a skull made of opal that was attached to the wall as if it were the prize of some hunt, and what appeared to be a genuine dinosaur fossil.

The white chalk wall was adorned with plaster craftsmanship modeled after a silvery vine pattern drawn with such minute detail that it made one's head spin. It spoke to the vast amount of time that had gone into fashioning it... The absurd authority and power to produce, collect, and still maintain such riches... The overwhelming, awe-inspiring influence.

The Milizé family was a well-known house in the Republic and boasted a great deal of wealth and history, but it was still a house of former nobles who'd lost their status and their right to taxation three hundred years ago in the revolution. The riches here were on another level entirely.

She didn't let her feelings show on her face, but she was still a bit unnerved. She looked to Shin, who seemed as indifferent as ever, in contrast to her. He was leaning his back against the wall and folding his arms—this was likely a habit of his. His bloodred eyes were cast down in what seemed like contemplative silence.

Looking around, she found Raiden and Shiden, who'd come as escorts. Raiden stifled a yawn like a bored wolf with more time on his hands than he knew what to do with, and Shiden was tampering with her tightly fastened tie, but she didn't seem particularly overwhelmed by the spectacle. Frederica naturally sat on the ball-and-claw-footed sofa as if she felt right at home in this lavish setting.

The Eighty-Six valued little outside the battlefield they'd grown up on and their routine mortal combat. Anything that would imply status or garner respect in normal society didn't really leave an impression on them. As such, the lush interior and extravagant decor had little impact in their eyes; it wasn't as if the furniture could bite, after all.

Easily imagining them coming up with that kind of answer, Lena smiled slightly. In the event that she asked Shin if this kind

of setting made him uncomfortable, she imagined that was the kind of answer he would give. The only things they found intimidating were the Legion they fought, and the only things they valued were the skills and knowledge needed to survive in battle. The world of man—with its rules and standards—was something utterly foreign to them.

Unusually enough, they were all wearing full formal attire, which was usually reserved for social events. Lena couldn't recall seeing them wear anything like that previously, and the sight soothed her strained nerves a bit.

According to their dispatch plan, only the brigade commander, Grethe, was to hold an audience with the king and the crown prince. Annette was sent to greet the technology division with Shana as her escort, and Lena's group was sent to meet the fifth prince in an official capacity, since both he and they were military personnel.

Still, the person in question was royalty. One would have to mind their appearance. Lena was a given, of course, but even Shin and the other Processors came in full Federacy dress uniform, complete with their medals, armbands, and Sam Browne belts. They even had several service ribbons, which they didn't normally wear, pinned to the left breast of their blazers.

After exhaling the air in her lungs with a sigh, Lena steeled herself. *Let's go.*

"It's the first time I've seen you all in dress uniforms."

There was a considerable pause before Shin responded, likely due to the glance his crimson eyes sneaked at her.

"...That makes sense. We don't really wear them outside of ceremonies."

The curt manner of his response made relief wash over Lena. It was Shin's usual tone.

"Ceremonies?"

She gave her reply in a natural, casual tone. That was good.

"Like the enlistment ceremony... And award ceremonies."

"Oh."

Every army would publicly celebrate distinguished war service as well as the war wounded as a way of encouraging the former and pacifying the latter. It was also a great way to boost morale.

It was different for Shiden, who was still a relatively new recruit, but Shin and Raiden, with their two years of military service in the Federacy, had already accumulated a surprisingly large number of medals. Of course, it was too soon for them to receive one for long service, but they did have medals for their capabilities and achievements. They both had impressive Legion kill counts, so their medals likely indicated that.

"I'd have liked to see those... Do you think if I asked the president, he'd have pictures or footage of it?"

The Federacy's temporary president, Ernst Zimmerman, was Shin's legal guardian and was the kind to proactively keep those kinds of records. Shin, however, simply frowned.

"Please don't. There's nothing fun about watching that."

Which meant there certainly were some records. Lena decided she would ask Ernst for them when they returned to the Federacy. However reluctant Ernst may be to share them, Grethe would probably manage something.

Lena heaved an internal sigh of relief over the success of her first attempt at idle conversation with Shin in a while.

Thank goodness. At the very least, he doesn't seem to hate me for what I said.

She then went on to ask something else that was on her mind.

"Er... Is something bothering you? You've been acting strange for some time."

Or rather, ever since they entered the United Kingdom's territory. At Rogvolod City Terminal, on the train to the capital, and when they were led to the rooms prepared for them in one wing of the palace. Every now and then, Shin's gaze would turn nervously in an unexpected direction. And he'd been like that since they'd come into this room, too. Something was bothering him, like a hound attentively perking up his ears, picking up something a human's sense of hearing couldn't.

"Yeah..."

Breaking off his words, Shin fell quiet for a moment. His silence felt oddly hesitant, as if he himself wasn't convinced about what he was about to say.

"...I can hear the Legion's voices from close by. I don't have an exact number, but there's quite a few of them."

“Wha—?”

Having almost yelled out in surprise, Lena hurriedly restrained herself. Feeling a suspicious gaze turned her way from a blond-haired, blue-eyed Emerald chamberlain standing in the corner, she stifled her voice.

“Why did you keep quiet about it until now? The United Kingdom already knows about your ability. You should have warned us if a raid was coming...”

Her tone came across as sharp in spite of herself. Preparing for a Legion raid ahead of time could greatly diminish the number of casualties, and no country had managed to develop a means of gaining recon on the Legion with as large a range or degree of accuracy as Shin’s power yet.

But Shin simply responded with a confused expression, as if he was uncertain about what he was saying.

“Because they’re *too* close. Judging from how close the voices are, they’re definitely coming from within the capital, and the closest one is here, inside the castle. I can’t really assume they infiltrated.”

It was, after all, a national capital. Arcs Styrie was a good distance away from the front lines, with a great deal of defenses standing between them. Even if the Legion had infiltrated behind the front lines, it was unlikely even a single self-propelled mine would have gotten this far.

“I thought an Eintagsfliege might have managed to fly in somehow, but there’s too many voices for that. It’s likely Legion they captured for research purposes. If nothing else, I don’t think any fighting will break out.”

“—Close but no cigar, as they say. But as you’ve surmised, there’s no danger to be wary of. Please ignore it, if you would.”

There came an unfamiliar voice. It echoed sweetly in the ear, with a permeating tenor that felt accustomed to making speeches but still rung as the voice of a boy near their age. A youth clad in the United Kingdom’s violet-and-black uniform with a stand-up collar entered through a door held open by a chamberlain.

He had the thin physique of a young man in his late teens. The United Kingdom’s royalty customarily grew out their hair, but his was cut short, and he had the fair complexion characteristic of

those living in the north. His eyes were faintly slanted like a tiger's, with his features being an equal balance of dainty gentleness and inhuman cruelty. He had a somewhat androgynous countenance that came across as aristocratic, but for some reason Lena associated his overall appearance with a slender black serpent.

Sleek pitch-black scales. Beautiful eyes the color of purple lightning.

A cold-blooded beast, devoid of human empathy.

The boy gave a sinister smile, narrowing his cold, gemlike, Imperial violet eyes.

"I apologize for the wait, dear friends. I am Viktor Idinarohk, your comrade starting today.. Allow me to first greet you. Welcome to the unicorn's castle."

The prince made his way over to them, accompanied by the sound of his military boots clicking against the agate floor and the gentle rustling of his clothes. His outfit gave off the scent of southern frankincense. Lena caught herself starting at him, forgoing all notions of manners and etiquette. His beautiful facial features stood in contrast to how naturally his uniform gave off a sense of overpowering, solemn dignity.

"So His Majesty the prince himself really came to greet us."

The prince raised his brows in an exaggerated fashion.

"You already have a grasp on our weakness, I believe... The United Kingdom was where the Mariana Model, which went on to become the basis of the Legion, was developed. Even if the war were to end, the other countries would no doubt regard us with disdain."

"..."

There was no direct causality between the development of the Mariana Model and the war with the Legion, but things would likely play out as the prince said. When calamity strikes, people tend to look for a cause. Even if it requires a great leap, or rather lapse, in logic, they seek to pin the blame for the wrongs done to them on someone else.

"Though I suppose we'll be better off than the Empire, which

developed the Legion, or rather its successor, the Federacy... Though even if they don't intend to admit to or take any responsibility for it, they still exhibit enough good faith that it is unlikely anyone would demand it of them. The people are more swayed by a country that extends a helping hand to its neighbors than by one that wouldn't even protect its own citizens."

He then shrugged in a detached manner... Perhaps it was due to his life in the military, but his gestures didn't come across as the least bit regal.

"And so the royalty gets sent around to make courtesy calls... But the same holds true, once again, for the Federacy. The Eighty-Sixth Strike Package. An elite unit composed of young men and women sent to give aid to other countries. The same deeds would not have been the slightest bit picturesque had it been coarse men doing them, but the story is quite different when child soldiers of such tragic roots are the ones doing the saving."

"Nng...?!"

Lena's breath caught in her throat. She'd seen and known the pity rooted in condescension that some of the Federacy's citizens showed the Eighty-Six. But for the Federacy's government to have sent them out on the premise they'd be pitied, hoping to use the Eighty-Six as a diplomatic tool to buy the other countries' sympathy...?!

Just how low could people stoop?

She felt an icy tone and warped smile nearly wash over her, but she quickly shook them off.

That can't be. People are more than just needlessly cruel and heartless. This is a time of war, and they might have to show only their most ugly facets, but...people, and this world, are actually...

"But, Your Highness... That's..."

The prince gave a sociable smile.

"Call me Vika, please. You can do away with the titles and empty formalities. They're a waste of time in the military, after all. And I'll address you all by your surnames. If you find it rude, feel free to say so, and I will correct myself accordingly."

Calling someone by their nickname was something that was permitted only for those who were close to that person. Considering the individual in question was royalty, it came across

as exceptionally cordial treatment, but as he'd said, it wasn't out of affection as much as a sense of rationality. After all, he may have allowed them to call him by his nickname, but he intended to stand on formality and address them with their last names.

As Lena opened her mouth to speak, he silenced her with a raised hand.

"I said there's no need for empty formalities, Colonel Vladilena Milizé. Your data has been disclosed to the United Kingdom, and I've taken the liberty of reading up on you ahead of time. You don't have to waste your breath on introductions."

Incidentally, the United Kingdom hadn't disclosed any information regarding him. At least, nothing that had reached Lena.

"...Well, it may come off as a touch impolite as exchanges go, but feel free to see it as us not having the leisure for such niceties and graciously forgive me for it. After all..."

He glanced at the large window with a view of the capital's streets, motioning at them to look as well, and curled his lips upward coldly.

"...as you can see, our United Kingdom is in an extremely critical situation."

Yes, it was plain to see.

Outside the window, thick, low silver clouds shrouded the sky, and snow fluttered gently down despite it being *late spring*, whitening out all other colors. Even in the Federacy, there were no more days of sudden chill, and in the Republic, early blooming summer roses opened up around this time. Even a northern country wouldn't have a midwinter-like snowfall at this time of year.

As Lena looked up at the clouds, she could see flickers of silver reflecting the lights from the ground at the edge of her vision. It was as if countless small shards of metal were reflecting the light. Like the fluttering of countless butterfly wings...

"Eintagsfliege..."

"Indeed. Even this land, beloved as it is by the goddess of white snow, would not be covered by its veil this late into the year."

That was the expression used by the United Kingdom to

describe winter, but there wasn't a hint of a smile on Vika's face. His eyes had the same coldness as the soul-freezing winter of the north.

"Because of the multilayered deployment of those metal clouds—the Eintagsfliege—the United Kingdom is rapidly cooling. Along with the capital, half of our territories' south is blanketed by their wings."

The Electronic Disruption type, the Eintagsfliege, was capable of deflecting and disrupting electronic waves of all kinds, light included. In the Eighty-Sixth Sector, their hordes resembled thin silver clouds that blotted out the sun, and on the Federacy's fronts, where their deployment was more intense, the sky seemed to be constantly shut out behind oppressive silver.

But there were no documented cases of them ever deploying in numbers significant enough to create snowfall during late spring, or over such a large radius...

"When did this start?"

"Around when the mass-produced intelligent Legion you call Sheepdogs became the main force. In other words, early this spring."

It was as she suspected.

"Our southern agricultural regions will be devastated at this rate... This country wasn't too blessed with sunlight to begin with, so the majority of our electricity comes from geothermal, coal-based, and nuclear power plants. But if we divert all our production plants to producing food, we won't be able to defend ourselves. If the Legion keep tightening the noose around our necks like this, by next spring, my country won't exist."

With a wave of his hand, a three-dimensional hologram appeared in the middle of the room. It was a solid map that displayed a simplified view of the United Kingdom's territories. As she saw Shin approach the map, likely sensing there was an explanation coming, Lena said, "If they use the same tactic elsewhere, the Federacy might be fine, given its large territory, but any other country wouldn't last."

"Yes. And that's why we have to nip their plan in the bud now, while they're still using the United Kingdom as a testing ground. Thankfully, the Federacy and the United Kingdom have the same

objective. The Merciless Queen you lot are looking for is deep within the Legion's territory, in the Eintagsfliege production site in the depths of the Dragon Fang Mountain."

The display showed the Dragon Corpse mountain range, namely the part near the border with the Republic, which was the United Kingdom's battlefield. It then switched to a three-dimensional model depicting the Dragon Fang Mountain, which lay deep within the mountain range. It seemed there was a production plant there. The hologram also displayed the estimated number of hostiles and the linear distance from the nearest front, which was an estimated seventy kilometers.

"The objective of this joint operation is the invasion and retaking of the Dragon Fang Mountain and the capture of the Merciless Queen."

"Precisely, Bloody Reina. We will have you shoot down the moon for us."

Gazing at the model of the Dragon Fang Mountain, which, as its name implied, was shaped like a massive fang sticking out toward the heavens with a typical rocky, pyramidal peak, Lena spoke:

"Your Highness."

"It's Vika, Milizé."

"Pardon, Vika. I would like for you to confirm the force you'll be commanding during this operation. I've heard your country employs autonomous unmanned weapons to defend its borders."

This was the reason for the United Kingdom's ability to defend its territory despite its national power being inferior to the Federacy's. Vika broke into a small, cynical smile.

"Half autonomous. We wouldn't make the folly of bringing fully autonomous weapons into the fray with the example of the Legion breathing down our necks. Besides, the United Kingdom hasn't reproduced an autonomous AI on the level of the Legion."

"But that's... Even you can't reproduce it, Vika?"

"It's not that I can't. I simply have no desire to."

The prince said this in a self-important manner, as if to say he could do it if he put his mind to it, with the same lightness as if they were discussing a slightly complicated cooking recipe. But even as the survival of his country and the countless lives of his

civilians hung in the balance, he easily cut down the possibility, saying he wasn't up to it.

Lena realized she'd gotten a glimpse of the cruelty of noble blood, which the Republic, with its emphasis on equality, wasn't familiar with. Blue blood, lacking any and all warmth.

"The drone you describe is called an Alkonost. It's a half-autonomous Feldreiß meant for combating large groups of enemies... In terms of ratio, they make up fifty percent of our forces, with the other half being our manned Barushka Matushkas, but the units under my direct command are almost entirely Alkonosts. Including my personal unit, Barushka Matushkas are only used for defending the command post."

"You say 'half-autonomous'... So they're operated remotely by humans—by Handlers, yes? Is the method of operation wireless? How do you bypass the Eintagsfliege's electronic disruption?"

"Alkonosts are connected to their Handlers via the technology you call the Para-RAID."

Lena knit her brows dubiously. The Para-RAID—Sensory Resonance—was a communication method that made use of linking senses, mostly hearing, by way of the collective unconscious shared by all humankind. In so doing, it overcame the obstacles of distance, physical obstruction, and all manner of jamming.

That, in and of itself, made it extremely groundbreaking technology, but since it employed the human collective unconscious, it didn't allow one to communicate with anything that wasn't human—namely machines, which didn't have a consciousness of their own.

Or rather, as far as Lena knew, it shouldn't have enabled communication with anything that wasn't human.

"B-but how...?"

"I'll show you right now. Lerche, are you there?"

He didn't raise his voice, but a response came from behind the door.

"Of course."

"I'll introduce you. Come in."

"Yes."

The door opened. Remaining at a distance that was a bit too

far to hold a conversation, the figure knelt in a lively manner.

"Tis a pleasure to make your acquaintance. I am Lerche, knight and royal guard to Prince Viktor. I serve as his sword and shield."

The figure spoke with a clear, high-pitched, pleasant voice, like the chirping of a songbird.

"The Republic's Lady Bloody Reina and the Federacy's Sir Reaper, Sir Wehrwolf, and Lady Cyclops. I've heard much of your military fame. Especially you, Sir Reaper. I would very much like to be instructed by you, if given the chance."

As mentioned, her voice was like lovely chirping.

"And as for the lovely princess over there, I welcome you to our snow-white country. I'm always willing to accommodate if playing in the snow suits your fancy, so feel free to call for me whenever you wish."

Redundant though it may be to mention again, her voice was exceedingly pleasant.

"...I'm sorry—give me a minute."

Vika raised his hands, walked over to the kneeling figure, and shouted at her lowered head.

"Lerche! Didn't I tell you to take this chance to change the way you speak to people?!"

She lifted her face in surprise. She was an Emerald girl with golden hair tied tightly in a bun and green eyes. She seemed to be the same age as Vika, which meant she was also roughly the same age as Lena and Shin. She was dressed in an old-style military uniform made of rouge-colored fabric and decorated with golden laces, with a formal-looking saber sheathed at her waist. She had petite, lovely facial features, and her thin eyebrows were scrupulously upturned in protest.

"What...? Your Highness, what are you saying?! This is proof of my fealty to you, and even *your* orders will not deter me!"

"What vassal would adopt a manner of speech that disturbs their master as proof of their fealty?! Are you an idiot, you seven-year-old?!"

"Good advice, just like effective medicine, is oh so bitter, Your Highness! And that is why, despite the sorrow it brings me, I treat you with undying respect! To have my actions seen under such

scrutiny shames me to no end...!”

Vika cradled his head in annoyance.

“Aaaah, confound it all—no matter what I say, you always have a retort...! What bloody fool tuned your linguistic features...?!”

“...With all due respect, Your Highness, the only one who has ever handled my tuning is you.”

“I know that—I’m just grumbling! By God, just ignore it!”



"M-my—I apologize for any disrespect...!"

The girl's reply was respectful yet despondent. Watching the conversation between the two, who didn't seem to mesh quite right, Lena couldn't help but giggle, albeit with pangs of guilt. She'd wondered what kind of man this King of Corpses would be, but seeing him frolic about with his friendly attendant made him seem like nothing more than a boy their age.

"...How do I put this? I suppose one's reputation really is removed from reality."

She whispered this so only Shin could hear. But no response came. Looking up at Shin, she found his expression was oddly stiff as he stared at the lord and his servant standing near the door. Specifically, his gaze was fixed on Lerche, the girl in the crimson uniform.

"...Captain? What—?"

Shin spoke up, cutting off Lena's query.

"...Your Highness."

Vika narrowed his eyes with interest—the Imperial violet eyes of an ill-natured tiger or perhaps those of a vicious serpent.

"I'll say it again, but Vika will do, Nouzen."

"Fine, Vika... What is *that thing*?"

"Captain...!"

When Lena realized the "thing" Shin was referring to was Lerche, she chastised him. Vika, on the other hand, gave him a thin smile.

"Ooh. I see your title of Reaper is well-earned, indeed... Lerche."

"Yes."

"Show them."

"Very well."

Lerche rose to her feet briskly, as if she were a knight taking off her helmet...

...removed her head, and held it up in the air.

No one in attendance could blame Lena for taking a frightened step back.

"What...?!"

Frederica's large eyes widened in shock, and Raiden and Shiden leaned forward from the wall they'd been standing against. Even Shin, who wasn't one for flinching, narrowed his eyes in suspicion. Vika alone remained composed.

"Allow me to properly introduce her. This is the first unit of the Artificial Fairies—the Sirins. The pinnacle of the United Kingdom's technological achievements and the crux of our national defense."

With a wave of Vika's hand, a sensor located somewhere in the room reacted, projecting a hologram near his slender form. That was likely the Alkonost. The three-dimensional model displayed a Feldreiß that was more slender than the Juggernaut, so much so that it made them doubt if it was armored at all. Its torso included a small cockpit hardly large enough to contain a human.

"This is the central processor of the semiautonomous combat machine Alkonost."

The Eighty-Six weren't considered human, so any machine they piloted would be considered not a manned one but a drone. It was the same concept...as the Republic's Juggernaut.

Lerche's detached head was connected to her torso with tubes and cords that looked like blood vessels and nerves.

"Is she...human?"

Vika snickered wryly.

"You ask that question after seeing what you've just seen, Bloody Reina? Recall what Nouzen just said. And consider...how did he so easily see her for what she is?"

Lena swallowed nervously. Shin could hear the voices of the Legion—or rather, the voices of the war dead who remained trapped mechanical ghosts. But the girl in front of them couldn't be a Legion, since they never fashioned weapons in human form. They were forbidden from making a weapon that looked too similar to a human being.

In which case...

Shin spoke, as if to not let Lena voice her conclusion.

"It uses a dead person's brain...or rather, a reproduction of one, as its central processor."

His bloodred eyes glared at Vika with an intensity Lena had

never seen before.

For Shin, who'd heard the voices of his comrades after they'd been captured by the Legion and who'd even had to gun down his own brother, who'd been trapped in that condition, the United Kingdom, which had made the girl standing before him, was guilty of unparalleled heresy.

It carelessly walked all over the line that separated the living from the dead. Capturing the souls of those who had earned their eternal rest and using them once again for the sake of battle meant...

It was an icy glare that would make any normal person falter, but Vika didn't so much as wince.

"Bull's-eye, Reaper of the Eighty-Sixth Sector. All of these girls' central processors are reproductions based off human brain structures."

They bore an odd resemblance to—or perhaps were inspired by—the intelligent Legion, the Shepherds.

"Wait a moment... If those were originally human brains, then..."

Lena's voice was so stiff and sharp she had trouble recognizing it. The United Kingdom was the only despotic monarchy on the continent. The citizens were all essentially property of the nobility.

"...where, and for what reason, did you gather the people those brains belonged to?"

Vika tilted his head in an amused fashion.

"Are you insinuating that we arrogant despots dismember our citizens against their wills? Then you may be disappointed to hear the Idinarohk line isn't quite that foolish. We know well enough that all that awaits us at the end of mindless tyranny is the guillotine's kiss... The components are all given voluntarily and are extracted only after they die in battle. Strictly speaking, it's right before their deaths. If a soldier who voluntarily donated his body in advance is marked as black during triage—and under those conditions alone—he's sent to have his brain scanned. Even those who volunteered aren't sent to the scanner if there's a chance of saving their lives, and volunteering is entirely optional."

In a place as dangerous as the battlefield, there were more injured soldiers in need of treatment than there were doctors to

treat them. To handle such situations, a method was established to ensure as many lives were saved as possible; that was triage. It was a measure to segregate those injured who weren't at risk of death or didn't require treatment right away from those who required immediate resuscitation.

Among them were black tags—those categorized as being in a condition in which they were beyond saving even if they were treated. The name came from the color of the tag attached to them. They were the ones who were found too late or the ones who were still alive but were injured to the point that they would die in a matter of moments.

"The digitized brain structure is reproduced via artificial cells, and after their memories are erased and their pseudo-personalities are installed, they're transplanted into the Sirins' skulls. In other words, they may be based off the war dead, but they're not the dead themselves. I am a bit surprised you can still hear them, Nouzen."

"But...why?"

The Legion used the brains of the dead, too, but they were weapons. They didn't have any perception of ethics and justice, of right and wrong, so it was understandable. But Vika was human... or rather, he should have been human.

"Why? I think it's quite obvious. Unlike the Legion, who keep coming no matter how many times you beat them back, humans are finite. Our ability to reproduce is limited. So if we can't lower the numbers of those who'll die, we need only recycle those who have already passed away. Send wolves to hunt wolves. Vampires to hunt vampires."

Ghosts to hunt down ghosts.

It was a perversion that made chills run through Lena's body—utter desecration. And unaware of Lena's aversion, Vika smiled. Like a serpent. Like a heartless beast, removed from the concept of emotions.

The King of Corpses. Devoid of sympathy and hence detached from humanity—the cold-blooded ruler of the dead.

"A-and...you call that...a drone...?!"

"Your words cut to the bone, but this is something you'll have to get used to. The weapons and soldiers the United Kingdom will

add to the Strike Package will be Alkonosts and Sirins. Namely, the regiment under my direct command.”

With that said, the prince of the north smiled calmly, regarding Lena as she shivered and Shin, who glared at him harshly, as if they were rocks on the wayside.

“Until we wipe out the Legion or until they exterminate humankind...I hope we will enjoy each other’s company.”

In one corner of the castle of the country that held the entire northeast under its thumb sat an Imperial villa. It was being used as a lodging house, and its rooms were pleasant, luxurious, and beautiful.

As she lay on a bed and compared the plumage inside it to the shabby ones she’d had back at the frontline bases and the internment camp in the Eighty-Sixth Sector, Shiden pondered how far they had come. While she couldn’t say this bed was uncomfortable or something she couldn’t get used to, she got the feeling sleeping on it too long would make her go blunt. In both mind and body.

Slapping her palms over sheets that smelled of flowers or some other herbal scent, the Brísingamen squadron’s vice captain, Shana, leaned over Shiden, who lay faceup on the bed.

“Hey, Shiden.”

Not bothering to turn her gaze toward Shana, Shiden gave a noncommittal response.

“Mm.”

“Is it all right?”

“Yeah...”

She didn’t specify what “it” was, but they’d been together long enough for Shiden to understand even without any explicit statements. The shock was probably too much. Ever since she’d met the prince that afternoon, Lena had been crestfallen, and Shin, who had walked up to her when he saw her sunken into the lodging house’s sofa and lying still, would be by her side right about now.

“Not much we can do. Her Majesty made her choice.”

“But...”

Shiden fixed her two-colored eyes on the window located right above her.

"There'd be more to think about if the Li'l Reaper was more of a jackass. But all things considered, it's fine, I guess."

She'd checked only briefly that he was all right, but that was all. It was in no way an acknowledgment.

"...No one can tell when everything will end. Same as always, really. In which case...so long as I'm at her side, I don't want to be a nuisance."



"—It is ever so dreadfully cold here... But the city flourishes! More so than one might expect of a capital in wartime, I daresay."

The United Kingdom's capital of Arcs Styrie was an old city with a history as storied as that of the country itself. The townscape told of prosperity, development, and the countless disturbances and upheavals in its past, with a peculiar view of many buildings, each built at different times across multiple centuries. The trend was that the exteriors were painted in bright colors, in a manner typical of a land under the cover of snow for half of every year.

Today, too, the Eintagsfliege's clouds hid away the sun, and light snow flitted down from the heavens. The main thoroughfare was full of passersby, with colorful shops and stands making up the market. Wearing a Federacy coat over her Republic uniform, Lena looked around at the lively town with her eyes wide. Annette, also in a coat, as well as Grethe, Frederica, and Raiden, who'd come as their escort, looked around curiously, too.

That day after breakfast, the chief of the technology division—a man so thin he was almost skeletal—had proposed that since they had some free time, they should go out and see the capital, pointing out that the ladies would also get a chance to shop that way. Half of the offer stemmed from consideration, and the other was meant to uplift diplomatic relations.

And indeed, they wanted to show off the abundance and prosperity of their country to the first field officers visiting from abroad in over a decade—and in so doing also casually stress the

strength of their army.

Shiden and Shana had passed on the opportunity, while Shin had seemingly been called upon by Vika, so they'd stayed behind in the palace. The royal guards had invited Shiden's group to take a tour of the military museum instead.

"Amazing... I guess that's what one might expect from the thousand-year capital of the mighty country of the north, Roa Gracia..."

"I think we needed a break, so that officer's offer came at just the right time. That technology really is a bit hard to swallow."

"I'm glad both of our sides had something to teach the other about the Para-RAID, but... Even if they say they used willing volunteers, it's one record of human experimentation after another... It's a little, kind of, really... You know..."

Exchanging bitter smiles, Grethe and Annette discussed the Sirins and their related technologies. Hearing that this technology couldn't quite be adopted by the Federacy made Grethe cradle her head despondently.

Some of the structures making up the glamorous town were barracks, armories, and other military installations used by the capital defense division headquarters, and many of the people walking about were clad in the United Kingdom military's purple-and-black uniform. Just like in the Federacy, soldiers were seen as subjects deserving respect. A young Beryl female soldier walking nearby was greeted with a polite nod by an older, violet-haired Iola man.

Looking around, Annette said, "Viola are the citizens, and the other ethnic groups from conquered territories are serfs, right? But all things considered, serfs get to live normally."

Pureblood Viola children—that is to say, citizens—were playing about with a ball, but serf children from other ethnicities were playing by their side as if there was no difference between them. A pair of people of different colors were sitting at the same table in a café, chatting over coffee. An old Celesta lady running a stall was currently ardently arguing over the price of a large jar of honey with a Taaffe woman. The negotiations concluded with a tight shake of hands, after which the two exchanged a bill for the merchandise and parted with smiles. "I'll come again" and "You're

always welcome,” the two said with pleased expressions.

Overall, the serfs were the working class, and the citizens were the middle class, and as such, there was a difference in the quality of their clothing and personal belongings, but the serfs weren't considered slaves or untouchables—there was no indication that some children were treated as a lesser race, like the Eighty-Six once were.

The palace guard assigned to Lena's group as their guide and interpreter smiled. The United Kingdom's official language was different only in dialect from the Republic's and the Federacy's, but since some of the serfs were descended from conquered territories that had different cultural spheres, a number of them spoke in entirely different languages.

“The citizens are expected to give military service, while the serfs are expected to handle production,” explained the guard. “In a way, it's a difference between conscription and tax liability. But with the situation the way it is right now, the royalty is encouraging the serfs to voluntarily join the military.

“Like him,” he said, gesturing toward a sentinel. He was a reserved Rubis man who looked about twenty years old, wore a brand-new second lieutenant rank insignia, and smiled at them with sheepish pride. All this meant was that higher education was open to all, at least those with the means to afford it.

As Vika had said, the United Kingdom may have been a despotic monarchy, but it didn't put any political pressure on its citizens. It did nothing that would stir up unrest or insurrection, nor did it create unnecessary class differences. Unlike the Republic, which, after taking everything away from the Eighty-Six by confiscating their assets to fund the construction of the Gran Mur and forcing them into conscription, had marked them as subhumans.

“...Milizé? What's the matter?”

“Nothing.”

Shaking her head vaguely, Lena then said doubtfully:

“By the way...I wonder what business Vika had with Shin?”

Shin was told to come with his coat on, and rightly so, as the

underground staircase Vika led him down was extremely cold.

"The northernmost mountains in the United Kingdom are the Frost Woe mountain range. There's an ice grotto there extending all the way to the Kingdom's underground, where the royal mausoleum was built. The ice here never melts, so it's frigid even in the summer... It's a huge mess if one of the servants' children sneaks in here carelessly."

The staircase itself, which seemed to be carved out of glacial stone, drew a gentle spiral as it descended deep underground. The place was inlaid with great-green-turban shells shining in the seven prismatic colors.

The Federacy military's issued trench coat was made for fighting in the frozen trenches of the Federacy's snowy north and was both waterproof and protective against the cold. Still, Shin furrowed his brow as the cold stabbed into his lungs with each breath he took. Vika, who was walking ahead, was breathing out equally visible puffs of air.

"...In olden times, those of noble birth were naturally royalty. Kings were seen as living gods given flesh, gifted with unique powers. A Pyrope's telepathy and psychometry, an Onyx's martial prowess, a Celena's intimidation. Many of those lessened and faded with the mixing of blood and the passage of time, but they still somewhat remained in lands where royalty and nobility retained their authority and bloodline. That applied for the Empire of Giad and the United Kingdom, as well. Among those was the Amethysta's augmented intellect—put simply, bloodlines that produce extraordinary geniuses."

Only one pair of footsteps was audible; Shin made no sound as he walked, and there was no one around but him and Vika. Being a commander, if Vika had business with anyone, it would be Lena, but he'd called Shin alone. Shin, a single Processor who would usually be seen as nothing more than a pawn.

Vika's intent here was unclear. With his voice thick with the strong aversion he'd felt upon seeing the Sirin, Shin asked a question with a terribly curt voice. He couldn't be bothered to pay respects to one of higher authority to begin with.

"...Why are you telling me this?"

"Hmm? Because you are a Pyrope Esper, of course. Your

bloodline on your mother's side, the Maikas, died out during the persecution of the other Eighty-Six... I thought you would be interested in learning a bit about it. Was I wrong?"

"I don't care for it."

"Hmm?"

Vika turned to face him with a somewhat dubious expression but eventually turned around again and shrugged.

"Well, regardless of whether you're interested, this is sadly a necessary preface to my main topic here. Bear with me patiently, even if you find it boring."

Vika descended from the last stair in the long staircase, the sound of his military boots resonating heavily. At the end of the aged passageway was a sudden shift into a new, state-of-the-art metallic door, which recognized something Vika was carrying and opened automatically. Frigid air, even compared to the chilly staircase, poured out silently from the doorway, but Vika paid the cold no mind as he crossed the threshold.

"The royal family is the last Amethysta bloodline to carry Esper abilities, and we are at the same time guardians of much knowledge and wisdom that would otherwise be lost to the ages."

Light illuminated the unknowable darkness, radiantly shining and twinkling over all. The place was a huge dome that seemed to be fashioned entirely out of ice, filled with transparent blue as far as the eye could see. The ice was so thick the rock face behind wasn't visible through it. An endlessly transparent, bottomless blue.

Countless icicles extended down from the dome's ceiling, which felt like some kind of pagan chapel, and a path of ice extended farther in from the spacious area they were in. Almost annoyingly, even here the ice was inlaid with malachite and amethyst in the shape of a peacock's feathers, which twinkled from the surface of the icy walls.

But what caught Shin's attention straight ahead was no collaboration between the natural and the artificial. Running along the dome's icy walls and on both sides of the passageway, like formations of crystals, were countless...

...coffins made of ice.

The coffins were egg-shaped and crafted out of silver and

glass. Each of them contained a figure clad in a purple-and-black uniform or dress. Most of them were adults, but some coffins contained children or infants. Others contained what looked to be only pieces of bodies wrapped in bindings or some personal effect buried in their place. The interior was filled with highly transparent ice, and the emblem of a unicorn carved into the glass's surface using a laser was entwined with a thin layer of frost.

Standing among the coffins, Vika turned around, the hem of his white coat spilling forward.

"And as a symbol of that legacy, our remains are preserved. All those descended from the Idinarohk line are enshrined in this frozen mausoleum. The earlier generations are already more or less mummified by now, of course... Now, then."

He gestured toward a coffin standing right behind him. The one next to it was still empty. Within that casket was a woman spreading out her hands as if floating on water with her eyes gently closed.

"This is Mariana Idinarohk—my mother."

The remains of the woman sealed within the coffin closely resembled Vika, who stood right in front of her. Had it not been for the differences of age and sex, they'd have been spitting images of each other. She seemed to be in her late twenties or her thirties and was dressed in a magnificent violet dress, the color of the United Kingdom's royalty, and on her forehead was a silver tiara set with cut gemstones.

But it was then that Shin felt something wrong. The delicate silver tiara set on Queen Mariana's remains. Of all the deceased lined up here, she was the only one to wear a crown. And even Shin, his knowledge of adornments being as meager as it was, could tell its position was off. A tiara wasn't worn right above the eyes, after all.

And right below the silvery gleam of the tiara, a straight red line was cut into her white forehead. Unlike the living, a wound inflicted on a corpse never healed—a part that was cut open never truly closed.

Vika smiled faintly.

"So you've noticed... That's right. My mother's corpse is missing its brain. Because I extracted it. Thirteen years ago."

There was no way Shin wouldn't realize upon being told that. The Legion had been developed twelve years ago. And also...

Mariana.

"The Mariana Model..."

"Yes. The artificial intelligence that was the basis of the Legion, the blight of humankind. The component that composed it...was my mother."

Or rather, her brain.

So this was how, Shin thought bitterly. This was how the Legion had come up with the absurd idea of assimilating humans' neural networks to replace their central processors. If they were originally based on a human brain, in an attempt to reproduce one, then they were simply functioning as designed, in accordance with the hypothesis.

But one question remained.

"...Why?"

That one question was overflowing with doubts. Why make such a thing? Why go so far as desecrating your own mother's remains? Why use your mother—even if only her corpse—as a guinea pig?

But Vika simply shrugged plainly.

"I wanted to meet her."

Despite them being the same age, and contrary to his graceful appearance, he spoke with the tone of a small child.

"Mother passed away soon after giving birth to me... I was a difficult delivery, and she lost too much blood—something that can happen during any childbirth, and as far as Father investigated, there was no foul play involved. And yet..."

Breaking off, Vika looked up at his mother in her casket. Those white hands, which may have never even held him.

"...I never knew my mother's voice."

The words spilling from his lips were filled with a longing for something he'd never had—and so they resonated with terrible loneliness.

"Even the Idinarohks' Espers can't remember what happened

right as they were born. I've spoken to Father, Brother Zafar, and my wet nurse, asking them to tell me all they could remember of her. But it couldn't fill the void."

"..."

"—But if that's the case..."

His thin lips then suddenly contorted upward in a lurid, vicious smile. Vika grinned, his Imperial violet eyes shining with reminiscence. Like a monster. Like a demon. Somehow Shin knew that thirteen years ago, a Vika so young Shin couldn't imagine him had had the same smile on his lips.

That all-too-innocent smile.

"If I don't know her—if I lost her—I need only bring her back. That's what I thought... Because her remains—her brain, with all her memories and personality intact—were preserved right here...!"

Fanatical delusion, completely absent of all restraint. He would defile a person's remains, seal their memories and personality in a machine, and in so doing, transcend death... His eyes were absent of all guilt or dread at the prospect of having committed such a taboo. There was no distinction between good and evil. Nothing but the utter coldheartedness...which saw satisfying his desire as the one and only absolute.

A cold shiver the likes of which he'd never known before ran through Shin. He was unable to see his own expression but was well aware of how severe and tense it was. The thing standing before him wasn't a human, but a genuine, innocent monster that knew neither humanity nor reason.

Swallowing his emotions, he asked:

"...And then?"

Vika shrugged casually.

"I failed."

The dead can never again truly walk among the living. Even Vika couldn't overturn that law.

"Mother's brain was lost for naught, and I was faulted for desecrating the queen's remains and stripped of my succession rights. Which was fine; I never wanted those to begin with, but... at the time, I hadn't given up on my mother yet."

He'd thought perhaps his mistake lay in being too young.

Maybe his knowledge was lacking, or perhaps there was a hole in his theory—he'd failed because he'd gotten something wrong. That was how Vika still saw the world at the time. That if one were to employ the right method, the desired result would always occur. He innocently believed that the world worked in such a neat, satisfying way.

He believed that things would always go well.

"So I uploaded all my data to the public network."

At the time, he didn't imagine that it would be an act that would rattle the military balance of the surrounding countries. He may have been the youngest child, but he was still the prince of a large kingdom. His name was well-known even though he was only five years of age. His writings had neither the appearance nor the linguistic composition of something worthy of being called a thesis, and given the absurd topic of resurrecting the dead, most researchers didn't even spare them a single glance. However...

"That's when you met Major Zelene Birkenbaum."

"Yes. A few curious, whimsical people contacted me from different countries, and she was one of them."

One of the few who, despite the writer's age and childish writing style, recognized the potential of this new artificial intelligence model was Zelene. At the time, she was researching autonomous weapons in the Imperial military laboratory.

"I knew what Zelene was researching and what she was thinking when she developed those autonomous weapons—the Legion. But..."

He didn't think she would end up turning that weapon against him. That the Empire would bare its fangs at all other countries. He never realized the consequence the actions he made to fulfill his dream would result in—

"...by the time the Empire declared war, Zelene had already passed away... Albeit indirectly, I'm the one who stole your homeland and family away. Do you loathe me for it?"

He spread out his arms. From the fluttering of his clothes, it was apparent that he didn't carry any firearms. He was completely defenseless, without a single escort or bodyguard to defend him. That was probably his idea of good faith. After all, Vika never told

Shin not to bring any firearms when he called him over. And Shin still carried his handgun on him, just as he had grown used to from years in the Republic.

But Shin answered, with his mind fixed on the familiar weight he was carrying:

"...No."

He had never thought of the Republic as his homeland, and he hardly remembered his family or anything else from that bygone era. If Vika said those had been stolen from him, he was likely correct, but for Shin...those no longer counted as things he had lost. It was the same as if they'd never existed to begin with, and if so, there was nothing to resent... Nothing to loathe.

"I don't think they've been stolen from me... And even if they were, you had nothing to do with it."

"...Once again, you speak indifferently, as if you never needed those things in the first place. Even though *you had a mother*, unlike me."

Vika shook his head with a bitter smile. His violet eyes clouded over with envy and jealousy for a moment, before those feelings were washed away in a split second.

"Now, then. While you seem quite disinterested overall, this concludes my confession. On to the main topic, the Eighty-Sixth Sector's headless Reaper."

How could one describe Vika's expression at that moment? It was both a look of entreaty and one of terror. As if he desired judgment and wished for hope. As if he desired both an affirming answer and words of denial and, while fearing them the whole time, couldn't help but ask:

"Is my mother...still here...?"

He wished to hear of his mother's eternal peace but at the same time wished to see her again.

So this is what he called me for, Shin thought in an oddly hollow mood. His ability to hear the cries of the deceased who lingered after death. With that, he'd be able to tell whether Vika's mother was still here or whether she'd gained the peace of death. Perhaps he would try again to resurrect her.

He'd attempt it or resign himself to give up...because he would know whether she was present.

Was that really something to be so fixated on? The thought crossed Shin's mind faintly. Shin couldn't remember his mother's face, but he didn't feel any lingering regrets over that fact. And still, Vika wished so deeply for a mother whose voice he'd never known, who'd never held him.

Standing eye to eye with Vika, Shin shook his head.

"No."

His brother, Kaie, and the many Eighty-Six who'd died were trapped on the battlefield, with the Legion using their brain structures as central processors. Despite the fact that they'd died and should have gone back to where they belonged, they remained trapped.

There weren't lingering thoughts or attachments, and they certainly didn't have any affection to them. Emotions couldn't overturn the rules of nature. The world...simply wasn't kind enough to leave that much behind. It wasn't kind to anyone, be they living or dead.

Kiriya's wish to avenge Frederica had burned down with the Morpho's destruction. And his brother—the brother who'd waited for him for so long—had disappeared once he'd lost the Dinosauria that had served as his container.

Gone. They weren't anywhere anymore.

"Your mother's remains are only a corpse. I can't hear any voice coming from it... Your mother isn't in there anymore."

"What about Lerche, then?"

Shin furrowed his brow, as the next question surprised him.

"What about the Sirins? You could hear the voices coming from them, right? Lerche is... They're inside those bodies. So do the souls inside those girls...long to pass on?"

".....Yes."

Shin nodded, wondering all the while why Vika cared so much if they were only parts of a drone to him. But Shin could hear it from them. It wasn't a scream nor a wail of anguish, but he could hear the lament in those voices. The voice of a girl he'd never met before and of countless unfamiliar soldiers.

"They keep crying...saying they want to pass on."

Vika gave a faint, light, but bitter smile. A self-deprecating grin.

"...I see."

Looking back at Vika, Shin parted his lips to speak. As always, he couldn't understand or relate to the person before him.

"Can I ask you something, too?"

Vika blinked once in what seemed like surprise.

"...Yes. If it's anything I can answer."

"Do you really want to meet your mother this much, when you've never even heard her voice?"

He'd understood this man felt no aversion to cutting open her remains. But still, it was a person's body, with the mass and weight of an adult woman. And the human skull was hard. And yet the then-five-year-old Vika still had to carry it away and cut it open. Had he really gone that far for no other reason than his desire to see her again? For someone whose voice he'd never known, someone he'd never met, someone who was his mother in name only?

Vika seemed dumbstruck for a moment.

"Well... Yes. Though they have different ways of expressing it, children love their parents. Especially so if they cannot meet them... Allow me to ask you in turn, but do you..."

Breaking off, Vika squinted.

"...not wish to meet your parents?"

"There's no meeting the dead again."

That was the irreversible cosmic law Shin—the one with the extrasensory ability to hear the voices of the dead—knew. He could hear their voices, but they were nothing more than the screams of one's final death throes. There could be no dialogue, no communication, no understanding established... No matter how much both sides may wish for it.

The dead can never mingle with the living.

"I see. Hence, you don't desire to remember them."

It was Shin's turn to narrow his eyes in scrutiny. Those words again.

It's not that you can't remember your childhood.

You don't want to remember it.

"...What makes you say that?"

"You have no interest in your late mother's genealogy. Despite the things that've been taken from you, you hold no resentment. But more than anything, the expression on your face tells of how

you don't wish to have that topic touched on—how you loathe to touch on it yourself. As if you suffer from a wound you don't wish to even acknowledge is there.”

“.....”

A wound.

Vika smiled, as if he'd seen through Shin. He unleashed his words cruelly, with a coldness that was almost merciful.

“But if that's something you're fine with, it's not my place as a stranger to comment on it... Taken to an extreme, a child's tendency to follow his parents is just another way of life. But if you deem it acceptable to forget even that...sure enough, you will see your parents again.”

CHAPTER 2

CITADEL OF THE SWANS

The United Kingdom's southern front's Revich Observation Base. The very picture of an impregnable fortress. Built atop rocky mountains, it was surrounded on all sides by precipitous cliffs with elevations ranging from a hundred meters at the lowest to three hundred meters at the highest, with diamond-shaped peaks to the north and south. The characteristically snow-white rock surface was now transparent and sharp, with the snow and sleet covering the incline making it thicker, and near the peak of the rock walls were palisades made of layers of reinforced concrete and armored boards. Another hundred meters away from the northern peak was another large mountain, which served as the fulcrum of a thick, reinforced canopy dome carved out of the rock face covering the peak, like a swan spreading its wings.

The only gate into the base and the road leading up to it was on an incline to the northwest, built over a winding, meandering steep slope filled with twists and turns. Overlooking the ascending road in the shape of an animal's entrails were the multiple menacing muzzles of gun turrets.

"It was originally one of our border fortresses, but right now we're using it as an impact-observation position."

There were holes dotting the canopy covering the summit, which stood like a pair of decaying wings. Trailing the pillars of

sunlight that shone down during twilight on snowy days, Vika led Lena and her group. It was a wondrous sight, formed by the glaciers' whittling down the mountains.

Following in his footsteps, Lena looked around the surface sector of the citadel base. This fortress would serve as the Strike Package's base for the operation in the Dragon Corpse mountain range. As it had originally been a fortress, barrier walls separated its interior into smaller sectors. A spiral staircase running counterclockwise led up to the castle keep built against the northern mountain. The castle keeps, which served as observation towers nowadays, were partially built into the mountain's interior, giving a panoramic view of the battlefield surrounding the fortress.

At the end of the gentle slope and currently out of sight were the United Kingdom military's artillery formation to the north and the contested zones to the south. To the east and west were the United Kingdom's armored encampments. The country's final shield, the northern mountain range, had been reduced to a Legion haunt by now.

In addition to the canopy blocking out the sunlight, the thick, high partition walls separating the base into sectors gave the surface sector a dark, suffocating feel. Shin squinted as he looked around, perhaps wondering how this place would fare should battle break out here.

"Impact observation?"

"This base is on the highest spot around here. Like all old bases, it isn't equipped to launch air strikes, but thankfully the Legion don't employ aerial combat, meaning even this old base is still usable depending on the situation."

While the Legion employed anti-air forces, they didn't have an air force of their own. Legion capable of flight weren't loaded with weapons and, based on past precedents, didn't use long-distance missiles, either. That seemed to be another restriction placed on them. So the United Kingdom took advantage of this weakness.

Snow gently flitted down from what should have been a late spring's sky.

They climbed the stairway leading up to the observation tower's third floor, which, for some reason, was a narrow spiral staircase, and after crossing three blast hatches to the underground residential sector, they were greeted by a shrill voice.

"Welcome back, Your Highness."

"Yes, hello, Ludmila."

A tall girl with almost unusually vibrant, flame-like red hair greeted Vika. She was followed by a group of girls who, like her, were clad in dark-red uniforms. The United Kingdom's uniforms were collared violet-and-black outfits. The dark-crimson uniforms, on the other hand, were exclusively worn by the Sirins.

In other words, all the girls in attendance were not human. Their heads were adorned with hair of various shades of blue, green, and pink, with a degree of glossy transparency that no amount of dye could produce. Violet-colored quasi-nerve crystals, which were in charge of Para-RAID functionality and thought suppression, were embedded deep in their foreheads. These crystals were connected to the very cores of their artificial brains.

Lena blinked as she looked around. Vika's ingenuity truly did border on the supernatural, since it could produce girls that looked indistinguishable from human beings. But did that power truly come without any costs? The thought concerned her. But setting that aside...

"They're...all women."

"Making them men would just feel disgusting."

Even Vika noticed the cold gaze Lena directed his way.

"I'm joking, of course. At least, half joking... When we first revealed them, the front lines were still occupied primarily by men, so we made them female as a means to differentiate them. At this point, the situation doesn't allow us to be picky, and since we have women and girls serving as soldiers as well, having the Sirin's hair colors be drastically different from the average human's ended up being a useful idea in hindsight."

Was it really necessary to have them look human in the first place...?

But as that thought crossed Lena's mind, she was overcome with shame. Just because they were mechanical, because their "human brains" amounted to nothing more than replicas, she'd

treated something with a personality of its own—even if only an artificial one—like a machine.

She also likely had trouble coming to grips with the *necessity* that they resemble humans, who were harder to manage and worse at attitude control. Lena imagined what it would be like if she were to wake up one day and find she had become a huge, disgusting insect. Her mental state would probably escalate far beyond simple confusion and despair. Having six legs, wings on her back, compound eyes, and feelers for sensory organs. It would be a sensation that was entirely unlike being human, and the human mind wouldn't be able to endure the shock for long before going completely mad.

...Rei had likely been the same. That young man who had so loved his little brother but had reunited with him after becoming a Legion and tried to take his life. He may well have felt the same thing. The instincts of his Dinosauria body—of a Legion that was far too different from a human being—had likely tormented him. To have his desire to see his younger brother again twisted into murderous intent...

She wanted to ask Vika for his opinion on the matter, but it wasn't something she could bring up in front of Shin. Even if she were to omit certain names, Shin was clever and would eventually realize what she was talking about... And even if he wouldn't, she felt as if she shouldn't speak of it.

Just as she peeked in his direction, Shin began talking.

"...Are the only things distinguishing them from humans their uniforms, hair colors, and the quasi-nerve crystals on their foreheads?"

"If you mean in terms of aid on the battlefield, the type of unit they pilot is fundamentally different, so that's another source of distinction. Worse, anyone who would try to treat their wounds would realize soon enough. They're almost entirely mechanical, and heavy enough for one to tell. The master data for their brain structures is stored in the production plant, and their combat records are regularly being backed up, so even if they're abandoned on the battlefield, it's fine... Also..."

Vika smirked arrogantly.

"...I wouldn't underestimate them if I was you, Reaper. These

girls were made for battle. They won't easily lose to humans in that setting."

"—Oh, Shin. Raiden and Frederica, too. You were transported today. Saying 'welcome back' sounds...a little off, but still, it's been a while."

Theo waved at them from where he sat at the corner of one of the long tables filling the room, and Anju and Kurena, who were sitting opposite him, turned around. They were in the Revich Citadel Base's third cafeteria, which was currently full of people, some clad in the Federacy's steel-blue uniforms and others in the United Kingdom's violet and black.

The citadel base's functions were all concentrated in the subterranean level built into the mountain's bedrock, and its multiple cafeterias were all set up in the underground residential sector. The well-lit ceiling was very high, but the lack of windows made the rectangular space feel oppressive. An azure sky was artistically depicted across the ceiling's surface, and the walls were painted with fields of sunflowers the artist so clearly longed for. The whole thing reminded Shin of a prison.

After each of them loaded their trays with food, Shin, Raiden, and Frederica sat down, and Kurena tilted her head inquisitively.

"I heard Colonel Wenzel and, um, Annette, was it...? The technical major chick. Anyway, I heard those two are staying behind in the capital, but what about Lena?"

"She's eating with the United Kingdom's commanding officers and staff officers."

"She is a commanding officer, after all. She's gotta play the role when it comes to social gatherings and stuff."

"Oh yeah... Looking back, it was like that when she'd just come to the Federacy."

As she spoke, Anju reached for several small jars in the center of the table, which contained jam, honey, and other such condiments to smear on bread. She shrugged and recommended the berry jam.

It seemed it was true that the United Kingdom was at the end of its rope. While it wasn't as bad as the Eighty-Sixth Sector, more

than half the food on their trays was the bland-tasting synthetic food from the production plants. If their means of food production were devastated...then indeed, they wouldn't survive the coming winter.

As Shin silently ate his meat seasoned with sour cream and his mashed potatoes, he could hear voices from the other tables despite not really trying to listen to them. The forces of this base were, putting the Strike Package's Processors aside, mostly Sirins, but it wasn't entirely unmanned. The Sirin's Handlers were there, of course, as were the infantry who served as the base's defense forces, the maintenance crew, announcement teams, and a gunner squad in charge of operating the base's fixed artillery cannons.

As per the United Kingdom's law that stated the Viola were the only ones who faced forced conscription, the majority of the soldiers had violet eyes. As Raiden regarded them, he furrowed his brow.

"In the capital, they said the only difference between civilians and serfs was their duties, but...it looks like that ain't the case, once you get to the bottom of things."

While there was no difference in the menus they were being offered, the Violas didn't sit at the same tables as people of different colors and ethnic groups. The serf soldiers' rank insignia indicated they were only normal recruits and noncommissioned officers, and even among fellow civilians, there was a difference in rank and visible antagonism between the Iola and the Taaffe.

Viola soldiers would look and speak to others with noticeable coldness. "Not only serfs but now foreign soldiers are stepping onto our battlefields. Deplorable. Our brave fatherland is shamed." So they said, despite the foreign officers being of noble birth in the Republic and the Federacy.

Theo turned his face away from them but stole apathetic glances at them out of the corner of his eye.

"Unlike the Republic, all the classy races are the ones that enlist... It's kinda weird."

"...? 'Tis the same in the Federacy, is it not? In Giad, the nobles fight just the same. Most of the current officers are former nobles, no?"

In ancient times, military service had gone hand in hand with the right to vote. Only those who fought had the right to make political decisions. Only those who fought could stand above the workers of the land. During that period, military service was seen not as a duty but as a privilege of sorts.

"I mean, yeah, but that's not what I was trying to say... It's like, in the Federacy you have the right to choose, but in the United Kingdom, it's like in the Republic. The color you were born decides your position in society and your duties... But those positions are reversed here. It's weird."

"....."

Maybe that's why, Shin suddenly thought. The color and ethnic group you're born into cement your place in the world—the duties you have to fulfill are decided the moment you're born. It's this kind of country that would come up with the idea of repurposing corpses for battle and would approve of using mechanical dolls meant for war. The civilians are the ones who fight, after all, and so their remains are also offered up for the war effort.

Just then, a pink-haired girl who looked to be in her early teens approached the United Kingdom's soldiers' table. She reported something, her face expressionless in a way that didn't quite match her youthful features. Not returning the smile of the Handler who spoke to her, she turned around and walked off...

Sirins didn't eat. So as not to needlessly waste energy packs, they were typically stored in a unique hangar except for when they were out on operations or training.

"...You hear about the Sirins?"

"Yeah, pretty much. Oh, be careful, though. Their Handlers don't like hearing people talk about them like they're objects. They kind of cherish them like they're their lovers or little sisters or something."

"I guess Handlers really treasure their drones in this country, huh."

Kurena spat those words out with disgust... Shin couldn't blame her. Even in a despotic monarchy that didn't place value on equality or freedom, Handlers treated those mechanical girls like human beings. Meanwhile, the Republic, which had equality and freedom etched upon its very flag, not only treated the Eighty-Six

as inhuman but couldn't even be bothered to lead them.

This was one brand of irony only they, the Eighty-Six, could understand.

Not even Lena could.

Human beings had a way of treating other people like objects or animals while, at the same time, cherishing objects and livestock as if they were people. Not even she could understand that all-too-ironic, fundamentally human cruelty.

When Vika came out, he saw Lena and drooped his shoulders.

"It's almost time for lights-out... Visiting a man's room this late at night leaves you a bit too vulnerable, Milizé. You should have Nouzen at your side when you're out and about like this."

"I have something to ask you... Something I don't want others, specifically Captain Nouzen, to hear about. Could we perhaps speak in private?"

This was why she'd chosen to come now, after Shin had retired to his lodging. Ignoring her, Vika headed to his own room. It seemed he wore glasses when writing and reading. He spoke as he removed his rather simply designed spectacles.

"Lerche, call anyone over, so long as it isn't Nouzen... Yes, Iida will do. Call her over. Oh, and you there, make sure the door doesn't close until Lerche comes back."

"Yes, sir."

"By your will, Your Highness."

"Vika...!"

Still consciously ignoring Lena's protests, Vika had a passing soldier hold the door as Lerche hurried off. After quite a while, Shiden showed up, after apparently having taken a hurried shower, accompanied by Lerche. Glancing at her, Vika made a dubious face.

".....Sorry. I didn't intend to interrupt... Or so I should say, but what were you doing?"

Despite being in the presence of a prince, Shiden turned her face away in utter displeasure.

"What I do in my free time's none of your business... Shit, you're not even listening, are you?"

"No, I'm not. Act as Milizé's guard dog for a bit. You may be a woman, but you're stronger than I am, if nothing else."

"Well, listen to you, prince. A fistfight is one thing, but where'd those calluses on your hands come from?"

"Hunting is a popular pastime in this country."

"Whoa, scary, scary. Guess I better mind my p's and q's so you don't end up treating me like wild game, huh?"

Shiden raised both hands in a joking manner and, as requested, plunked down on a five-person sofa like a lazy hound. In contrast, Lena sat down politely, and Vika sat opposite them. They were separated by a low table. Lerche set white porcelain teacups and a tray inlaid with mother-of-pearl and loaded with sweets on the table before moving to the back of the room. Then Vika spoke.

"Well? If this is something you don't want Nouzen to hear, it's about *that*, right...? Why me, then? I'm not knowledgeable about that."

"No, you're probably...the most knowledgeable out of everyone I know when it comes to this topic."

Something that was lost to the Republic and hidden behind a thick wall of military confidentiality in the Federacy.

"Extrasensory abilities."

Vika's expression suddenly turned blank.

"Captain Nouzen's ability to hear the voices of the Legion. Aide Rosenfort's ability to see the past and present of her acquaintances. These abilities offer great tactical advantages... But don't they harm those who possess them?"

That included Vika, the Idinarohks' Esper. As such, she wasn't sure whether asking him was a good idea.

"Oh... So that's what you wanted to know. I can see why those without extrasensory powers might think so."

Vika crossed his legs, ever aloof.

"As a principle, the answer to your question is no. Supernatural abilities have always been necessary for leaders to guide the masses. This has been true since time immemorial—since the era when those of noble blood were truly kings. For an Esper, their extrasensory ability is as natural as their other five senses. Does a living being capable of sight damage its body simply by seeing?"

The same idea applies here. There is no price to pay, so to speak.”

“But what about cases like Captain Nouzen, where his ability changed from what it could initially do?”

“Is that what happened? Well, I see. I did think it was an odd way for the Maika bloodline’s ability to manifest.”

Lena directed a puzzled expression at him, so Vika explained that was Shin’s mother’s clan. Apparently, it was included in the personnel file Vika had received.

“Such an example is rare, indeed... But if he sleeps for too long at times, it’s likely because he’s subconsciously stabilizing his balance of strain and rest. If he said he’s feeling unwell, it would be another story, but I don’t think there’s much cause for worry right now.”

“That...might be true, but...”

Vika tilted his head slightly, like a large snake eyeing some unfamiliar small animal. Without a trace of warmth or emotion.

“Let me ask a question, then. If I were to tell you it does have an adverse effect on him, what would you do?”

Lena blinked, seemingly taken by surprise.

“Huh?”

“To begin with, if you’re asking about that, why didn’t you bring Nouzen with you? If you think it might have a negative influence on him, it’s all the more reason for him to be present for this conversation.”

“...Yes, but...”

He was one of the Eighty-Six—his *raison d’être* was to never flee in the face of death.

“...Captain Nouzen would likely...still refuse to leave the battlefield.”

Vika blinked once, over a long moment.

“Are you implying...that he’s a pitiful Eighty-Six who’s been irreparably broken by war and rendered incapable of proper judgment? And you, a normal, good-natured human being, have the right to make that judgment call for him?”

Lena raised her face in a stiff gesture. She’d likely looked up at him with such a pale, hard expression. Vika’s lips twisted with a giggle, but something in his violet eyes wasn’t jovial in the slightest.

"Truly, you are arrogant. Like the goddess of white snow herself."

The snow goddess that enveloped the United Kingdom for half of every year. A beautiful, merciless, arrogant goddess who never spared an idle thought for the concerns of people...

"Yes, you really are unblemished, virginal snow incarnate. But does that give you the right to claim any other color is filth? Sure enough, Nouzen, much like that guard dog over there and the Eighty-Six as a whole, is critically lacking in a way."

As Lena reflexively looked her way, Shiden sipped her tea with great apathy. Lena somehow knew that even though she'd just been called lesser, she hadn't been fazed in the slightest.

"That's... I mean, yes, but..."

The sudden surge of emotion that welled up made Lena's hands, which rested on her lap, clench into fists. It felt as if something had squeezed her heart, and she felt dizzy. As if she was being gagged with a sticky lump of emotion that was making it impossible to breathe.

She finally realized why she'd asked Vika about something like this.

"I feel like if we were to leave Captain Nouzen—leave Shin—alone, he'd grind himself into nothing..."

And that terrified her.

"When the Sheepdogs were introduced, he slept for days on end. And he'd always say 'I'll get used to it soon.' And sure enough, the physician gave him the okay to return to service. But if the strain becomes any greater..."

Only Shin can truly hear the voices of the dead. I can't help him shoulder his burden. I can't share his pain. So if the strain gets any worse, this time he might really crumble into dust, without anyone noticing. And that...terrifies me. It makes me anxious. I want to do something before it comes to that.

"...Even so..."

Vika's voice was quiet.

"Worrying over this all on your own won't help anyone. If it bothers you, you should try speaking to him about it. And if you're anxious about that...bring him with you next time you come to me. I'll help however I can."

“...Yes.”

Vika then leaned his back against the sofa he was sitting on and cocked his head.

“But do you really have the leisure to be worried about people other than yourself? What with your motherland and its love of white, despite its flag being as multicolored as it is.”

“...So you know.”

“Of course I know. Do you have any idea how many soldiers I had to pacify to have your presence here accepted...? The Republic may be unrelated to the Legion’s development, but it is the most hated, loathed country in this current state of affairs. There isn’t a country out there that doesn’t see the Republic as a devilish killer of kin, and that’s a mark of Cain you will carry with you no matter where you take your battles. The stigma of a slothful country that, despite having been given a chance to atone through service to the Strike Package, sent only a mere handful of officers... I truly don’t think you’re in a position to worry for someone else’s well-being.”

“.....”

“With regards to the RAID Device, I’ve looked over the research materials Henrietta Penrose provided us. Including the results of the human experimentation done on the Eighty-Six... If the strain becomes too great, it can damage the user’s brain and influence their mind. And even knowing this, don’t you think Resonating with a brigade-size force is a bit too much?”

“It’s not quite a brigade-size force. I’m only Resonating with the squad captains.”

“Still, that’s quite a few people at once. Since they only know how to fight in small groups, the Strike Package is divided into an unusual arrangement of squadrons. In the United Kingdom, we don’t let anyone Resonate with that many people during operations. I doubt the Federacy allows it, much less the Republic.”

He then said that he was an exception, a cold gaze in his Imperial violet eyes—the mark of the genius pedigree that had been passed down for a millennium. The violet eyes of the Idinarohk line, members of which were capable of offhandedly producing inventions that revolutionized the world.

"The Para-RAID is a technology that reproduces an extrasensory power in those who lack it. If I use the example I brought up earlier, it's like a device that forcibly gives humans the power to see ultraviolet rays. If anything was to have adverse effects on its user, it would be the Para-RAID."

"That's... But still, I'm a commander. So I don't have a choice..."

She had to use it if she was to fight alongside the Eighty-Six.

"It's a risk I'm willing to take."

Vika gave a grand, resigned sigh.

"You freely give your grace to others like a saint, even as you're tormented by the possibility of it being needless concern. But when it comes to yourself, you're so dismissive. Truly, you're beyond saving... Lerche."

"As you command. Yet...even as you say that, your kindness knows no bounds, Your Highness."

"Shut up and stay out of this, you seven-year-old."

Chuckling all the while, Lerche passed through a door deeper in the room—which appeared to lead to a bedroom—and came back with something in her hands. Upon receiving it, Vika tossed it at Lena, who couldn't catch it in time and juggled it awkwardly in her hands. Shiden, who was watching from the side, reached out and caught it easily.

"The Thought-Support Device, Cicada. It was developed for Sirin Handlers and to ease the strain of the Sensory Resonance."

The Cicadoidea's Wings—Cicada.

Contrary to what its name implied, it was a choker-like device adorned with silver threads tinged with light purple that formed a delicate lace pattern. At its center was a light-violet quasi-nerve crystal, which upon closer inspection appeared to be finely spun out of the silver threads that seemed to extend from it.

"Unfortunately, it's not formally approved for use in the United Kingdom military, but it's confirmed that it's safe. The only reason it wasn't put into use was because the soldiers were opposed to it."

Opposed to it?

"Do you use it, too, Vika?"

"No?"

There was an odd pause.

"Er... This *is* a device to lighten the Para-RAID's strain, right?"

"It is, but it's no good for me, and even less so for the other Handlers."

"Why?"

Vika replied with utter seriousness, "What would having a man wear this achieve?"

"Um..."

Lena didn't follow.

Vika took the Cicada from Lena's hands, connected it to an information terminal, typed something into it (his previously removed spectacles were now back on his face), and after removing his spectacles again, tossed it back at her.

"I've reformatted it, so you can try it on in the anteroom over there. It should also have reset the measurements... Don't worry, there are no surveillance cameras in there."

"Oh... Er, thank you very much."

"It should go off on its own once you connect it to your neck... Oh, and..."

As the anteroom door closed, Vika turned away.

"...there's a, um, a trick to putting it on. Well... Good luck, I suppose."

The anteroom Lena entered, as well as the rest of the underground base, was built to be soundproof, meaning no voices could get in or out. Yet, despite this...

"Huh... Ah, ahhhhhhhhhhhh?!"

...Lena's scream pierced the silence of the commander's room, as it had slightly exceeded the soundproofing.

Ignoring that yelp, Shiden helped herself to another cup of tea, which she sipped noisily. She'd learned it was considered a rude habit since coming to the Federacy, but she didn't care enough to fix it. Staying in the same posture, she moved only her eyes in the direction of her former master.

After Lena had entered the anteroom, Vika had told Shiden about the Cicada and its use.

"...Just making sure, but it isn't dangerous, right?"

Vika stood facing the wall opposite the anteroom, plugging his ears, so Shiden was forced to write her question down on a piece of paper at the table's corner.

"Yeah. We've done more than enough animal experiments and practical tests. The only reason it's not officially used is because it was unpopular with the soldiers, as I mentioned earlier."

"Well... I can kinda imagine why."

Just hearing about it gave Shiden a pretty bad opinion of it. As Vika kept his ears plugged despite being in the middle of a conversation, Lerche tilted her head quizzically.

"Incidentally, Your Highness, why are you adopting such a peculiar stance?"

"Can't you tell? Listen, I don't want to get myself killed."

"I...see."

"If that headless Reaper finds out about this, my head will roll, too."

"How horrid."

Lerche's Emerald eyes widened.

"In that case, Sir Reaper is enamored with Lady Bloody Reina! How unexpected..."

Vika and Shiden simultaneously whacked Lerche over her golden-haired head and then together shook the pain from their hands. Lerche's skull was metallic, after all. It hurt quite a bit.

"Holy shit... Is your brain rusty or something, you idiot?"

"You shout that here and now, of all places and times? Forget that—it took you this long to notice, you seven-year-old?"

"M-my shame knows no bounds..."

Thankfully, none of this screeching reached Lena's ears.

The Processors had been appointed a section in the base's residential block. Given that space underground was limited, the rooms were meant for four people each. Shin was sitting on the top bunk of his bed, his eyes fixed on the novel he was reading, when he suddenly lifted his head at the sound of a voice from afar.

It was different from the Legion's cries. A distant voice from somewhere...

"...Did you just hear someone scream?"

Somehow, he felt as if it was Lena's voice. Having been asked, Raiden peeked out from the lower bunk and shook his head.

"...No?"

After a while, Lena left the anteroom with her face bright red and her uniform in disarray. If Vika hadn't been the prince, she'd probably have slapped him across the cheek. Vika seemed to have been aware of that fact, but he spoke with a smile charged with noticeably false cheerfulness.

"I'm glad I could be of service, Your Majesty."

".....!"

Whoa, thank God Shin isn't here right now. So Shiden thought to herself as Lena glared daggers at the prince. Pushing the Cicada into Vika's extended hands, she turned on her heels in indignation.

"I'm leaving, Vika."

"Yes, good night."

Lena walked down the hallway, her embarrassment and anger audible in her footsteps, but as the indignant annoyance subsided, she was instead flooded with lingering regret and self-loathing.

Are you implying...that he's a pitiful Eighty-Six who's been irreparably broken by war and rendered incapable of proper judgment?

Again. I did it again.

"...Shiden, am I...?"

She asked this without turning around, but Shiden raised an eyebrow behind her.

"Am I a...an arrogant person?"

Shiden scoffed with disinterest.

"You're just noticing this now?"

Lena jerked in surprise, but Shiden continued, paying her reaction no mind. As if she was simply giving her opinion.

"I live the way I want to. And that holds true for that prince and for Shin, too. So you can do whatever you want, too..."

Sometimes you just gotta butt heads with someone. If it happens, it happens.”

“...But...”

Butting heads with someone... Not understanding him is... I...



The Revich Citadel Base’s eighth hangar. The Strike Package and the United Kingdom’s personnel stood in a well-organized formation in the largest hangar in the base, built in the lowest underground sector. A group of Juggernauts waited on standby in the shadow of the catwalks.

“—I believe this is my first time meeting most of the Federacy’s soldiers. I am Viktor Idinarohk, commander of the United Kingdom’s southern front forces. Ranks are pointless, so you don’t need to remember mine. It’ll change before long anyway. I won’t be in direct command of you, but, well, you can think of me as one of your superior officers.”

The odd atmosphere that fell over the Eighty-Six was likely a question along the lines of *Who is this?* Several of their gazes traveled between Vika and Lena, who stood silently beside the projected operation map. The deputy director of the United Kingdom military narrowed his eyes in displeasure, as if feeling the whole thing was disrespectful, but Vika simply sneaked a look in Lena’s direction and shrugged.

This boy truly was both a member of this northern country’s royal family and the commander of its southern front. Even when faced with over a thousand members of personnel, he didn’t lose his composure. Incidentally, Vika was also the supervising commander for the Sirins, and while he was subordinate to Lena if following the chain of command, he still held absolute authority over this base.

“The coming operation will be a collaborative effort between the Eighty-Sixth Strike Package and the southern front’s 1st Armored Corps. Our objective lies seventy kilometers south of the base, in the Legion’s territories—the complete suppression of a Legion production site located in the Dragon Corpse mountain

range's Dragon Fang Mountain."

It was a simple map, meant for providing information for corps-size forces, which presented the deployed United Kingdom forces and the opposing Legion force. The production base was marked with a red icon for emphasis. Compared to other confirmed Legion positions, it was one of the deeper and largest-scale ones. Since the southern Dragon Corpse mountain range stood as a natural defense along the United Kingdom–Federacy and United Kingdom–Republic borders, it was likely one of the Legion's headquarters for the anti–United Kingdom front.

"The Strike Package will lead the main attack, and the 1st Armored Corps will serve as backup. To be exact, the 1st Armored Corps will attack the Legion position as a diversion, drawing out and keeping the Legion's frontline and reserve forces in check. The Strike Package will take advantage of the resulting gap in their defenses to infiltrate and seize control of the Dragon Fang Mountain production site."

In accordance with the explanation, the United Kingdom military's armored unit's icon moved diagonally, detouring around the front squadron to advance on different positions. As the Legion's rear reserve forces moved, an advance route from the citadel base to the Dragon Fang Mountain production site appeared over the map.

However, the most important detail—the map of the production base's interior—wasn't presented. This position had been constructed by the Legion after the area had become part of their territories. The human side couldn't have a map of it. There had been a few attempts at scouting it out, but they only just barely informed the United Kingdom that a production base had been carved into the Dragon Fang Mountain.

"In addition, we will be prioritizing the capture of said base's commander unit, identifier: the Merciless Queen. It's an Ameise from the earliest production batch... Or, well, I suppose that's not as visibly discernable, but it's a white Ameise... While it's still only in the realm of speculation, there is a possibility said unit may be capable of providing humankind with information on the Legion. This information may or may not be a crucial component in ending the war. Therefore, we must capture it. Damaging it to

some extent is acceptable, but leave its central processor intact... Any questions?"

"In other words, we rush through the gap in the Legion after they take the bait, somehow beat the enemy, steal their ant queen, and then come back... Seriously, looks like any country we go to, everyone comes up with fucked-up ideas."

Unlike the Eighty-Sixth Sector, where most of the time they'd dealt with interceptions, an invasion operation required significant preparations. Since they would need to deceive the enemy into thinking the Dragon Fang Mountain capture operation was an all-out attack, they would need to create the impression they were scouting ahead to get a handle on the enemy's firepower. As Theo grumbled, Shin, who was concentrated on that task, lifted his gaze.

The Spearhead squadron marched through a snowy conifer forest, weaving between the trees in a tight wedge formation. Theo's statement was not made to the whole squadron but was transmitted via Para-RAID to only Shin, Raiden, Kurena, and Anju.

Since the United Kingdom's front lines were in a mountainous region, both their military and the Legion held their positions between opposing mountains, with the valleys and plains between them serving as the contested zone. This area was no exception, and the Eighty-Six were currently advancing down a path that was different from the one they would take during the operation three days from now. They'd descended down gentle slopes earlier and were currently scaling up a sudden precarious cliff face.

FRIENDLY UNITS

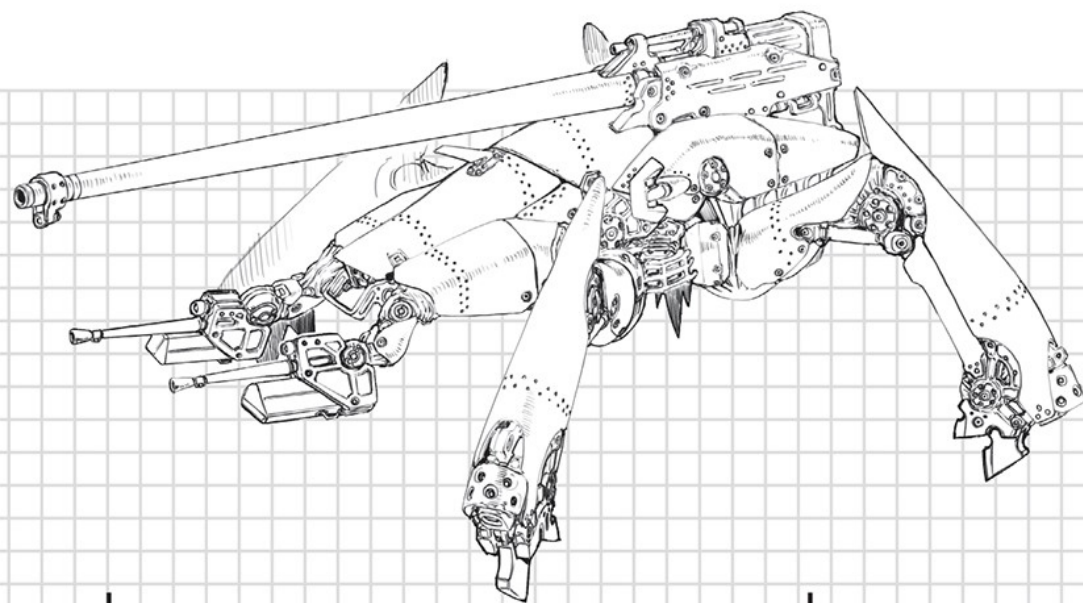

Much of the Federacy's territory is grasslands and wastelands, and as such, its Feldreß weren't equipped with countermeasures for extreme environments such as frozen terrain and deserts. The Feldreß dispatched this time were modified with measures that enable them to operate in snowy terrain and below-freezing temperatures.

[NAME]

XM2 Reginleif

Snowy-Terrain Configuration

[Additional Equipment]

Climbing Irons for snowy/frozen terrain [x4] [on tips of legs]

※ Various other measures were also taken, such as omitting the barrel's revolving mechanisms to reduce the unit weight and avoid freezing of any moving parts.

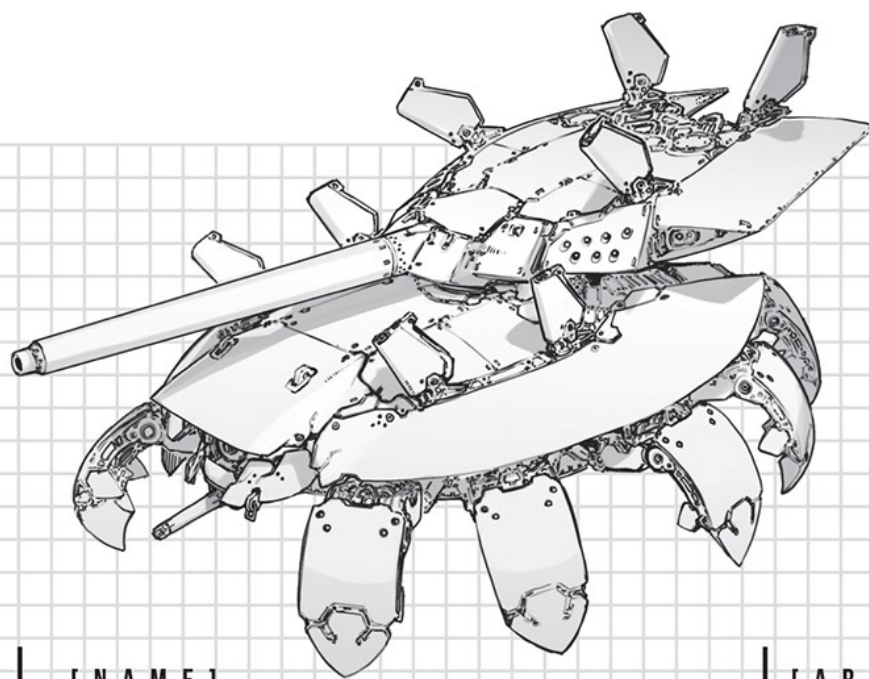

A Feldreß developed by the United Kingdom of Roa Gracia. Reflecting the state of affairs in the United Kingdom, where many personnel are lost in battle, it was developed to be capable of dealing with a variety of situations on its own while prioritizing the survival of its pilots. That design concept resulted in a heavily armed and armored unit. When going out into the field, the Sirins' Handlers board this type of unit.

[NAME]

Barushka Matushka

[SPEC] Manufacturer: 6th Royal Technological
Department Factory
Total Length: 7.0 m / Height: 2.7 m

[ARMAMENT]

125 mm Smoothbore Gun [x1]
7.92 mm Coaxial Machine Gun [x1] [equipped on right of turret]
14 mm Revolving Machine Gun [x1]
40 mm Grenade Launcher [x8]

Their radar screens reflected the three squadrons near them, as well as a pixel symbolizing Alkonosts sent on recon a few kilometers ahead. A force of Barushka Matushkas from the United Kingdom's armored corps was also advancing nearby. The Juggernauts passing through the trees had all had their armaments exchanged for light, non-revolving cannons and had long steel claws equipped to their legs for penetrating snow and icy surfaces. The snow that had fallen over the course of the long winter had hardened and frozen under its own weight, and they could hear the sharp sound of steel stabbing into the ice as they moved.

Lena asked Shin over the Resonance:

"Captain Nouzen... The Phönix's position hasn't moved from the Dragon Fang Mountain base today, has it?"

"Doesn't seem like it," he replied, directing his consciousness to the inorganic, mechanical scream disturbing even the silence caused by the snow's sound dampening. He'd realized the new type of Legion he'd encountered and let slip away during the last operation was here, on the United Kingdom's battlefield, soon after arriving at this base. It was somewhere in the Dragon Fang Mountain base, the objective of their operation... Where the Merciless Queen—potentially Zelene—who had hidden that message within the Phönix, might be. Their being together felt almost obvious.

"I think we can safely assume it will be set to defend the Dragon Fang Mountain base... It'll likely serve as our biggest obstacle in the upcoming operation."

"I don't think we'll encounter any problems so long as we deal with it as we've previously planned."

"Yes, but I propose we conserve that tactic for later. Perhaps after we get back from the diversion."

"Roger."

On the other hand, Raiden replied to Theo.

"Those heaps of junk have the upper hand and all the initiative no matter what country you go to. But if you consider the distance, situation, and the difference in our forces, this is much better than it was back in the Morpho-elimination operation."

"We might not have a map of the enemy base, but the Alkonosts will be handling all the recon for us. Apparently, we can leave that role to those girls from now on... But..."

Anju shrugged.

"...the fact that they look like girls our age gives me kind of mixed feelings about this. Even after I saw them walking through the snow just fine dressed in nothing more than field uniforms."

While Shin and his group were here, giving the impression they were on recon, the Sirins were scoping out the route the Strike Package would take during the operation, and since the Alkonosts would be quickly detected, it was only the Sirins themselves.

Shin's ability wasn't able to distinguish the Sirins' voices from the Legion's. After the Sirins had passed by so many Legion groups, Shin couldn't discern their positions, as they were scattered across the battlefield.

The United Kingdom drone that observed the Morpho... Shin narrowed his eyes in recollection.

Yes... You could consider it to have the same armaments a fair maiden might carry.

During the conference where they'd discussed how they would deal with the Morpho, the United Kingdom's crown prince had said that, referring to them as drones. Shin had heard about it from Ernst after the operation. As one might expect, even in such a meeting, the crown prince had spoken with elegance and poetic grace.

But that was no flowery figure of speech.

The drone he'd been describing back then was a Sirin. And so it was no metaphor; the payload it could carry was indeed limited to what a maiden could carry. It was smaller than a Feldreiß and thus wasn't as easily detected by probes and radar, but in exchange, the weight it could carry was about the same as what a human could. And in that case, if a Sirin had to carry communications equipment and a spare energy pack, it wouldn't be able to carry weapons. In order to observe the Morpho's roost in Kreuzbeck City, they'd had to send in multiple Sirins with equipment that would allow them to penetrate the electronic jamming, and all of them had been destroyed.

A humane operation, with no loss of human life... A humane

battlefield with zero casualties.

The Sirins were made up of the dead, so that wasn't a mistaken statement... But then Kurena, who had kept quiet until that moment, said:

"I mean... They're kinda... Y'know... Kinda creepy."

She spoke as if fearing the Sirin might hear her, despite the fact that only the five of them were Resonated.

"It feels nasty saying this, because it feels like I'm trashing them behind their backs, but...they're basically like walking corpses, right? I...don't really get how it works, but it's creepy."

Theo apparently cocked his head with an "Mm."

"Does it really bother you that much? It's not that different from the Legion... Like, Black Sheep and the Shepherds. All they did was just put a copy of a human brain in a human-shaped container."

"...I don't think it's on a level where you can say they 'just' do that..." Theo paused pensively. **"I mean, the Sirins aren't even all *that* human. They don't breathe, there's this weird time lag to their movements, their expressions are predictable, and their eyes are unfocused. They're more like human-shaped self-propelled mines that can talk."**

He listed off a bunch of discrepancies that never bothered Shin in the slightest. Since Theo's hobby was drawing, he likely had a tendency to observe his subjects more deeply. And Kurena probably found the Sirins to be creepy for similar reasons. She was a sniper, and snipers didn't usually aim at static targets.

No matter how fast the tank shell, there was a time lag ranging from tenths of seconds to a few seconds before it impacted the target, depending on the distance. With this much time, any target could move, be they human or Legion. To hit, a sniper would have to predict the trajectory and distance and have an observant eye capable of seeing any minute movements. Having gained those skills, Kurena had probably unconsciously picked up on the differences between a human and a Sirin.

"And really, they look human on the outside, but on the inside they're apparently pretty much like Feldreß. I hear that since they had to make them the size and shape of a human, their operation time and output are pretty limited."

"They have no senses except for hearing and seeing, and their stomachs

are loaded with their propulsion and cooling systems... They don't eat, don't have to sleep... I can't really imagine how it must feel."

"Assuming they even feel anything."

"Theeeeeo."

"Whaaat?"

Theo then realized and fell quiet. Shin felt Raiden wordlessly turn toward him but didn't realize what the matter was for a second. But after blinking once, he realized.

Oh. They were talking about his brother.

His brother, who had died in battle, had his head stolen, and become a Legion—Rei. Shin honestly wasn't bothered all that much. That Dinosauria had certainly been his brother's ghost, yes, but Shin didn't know whether his thoughts and consciousness had truly remained in there. The same held true for the countless comrades they'd failed to save from being taken away by the Legion.

So he didn't feel much aversion to considering a copied, mechanical brain structure as a machine and not a human. Except...

Shin sank into his thoughts. As Theo had said, there was no major difference between the Sirins and the Black Sheep, Shepherds, and Sheepdogs. They were reproductions of human brains, mechanical ghosts that couldn't even be called corpses. But even after he'd died and had his head stolen, even when he was just a copy, Shin had seen Rei as his brother. In which case, Lerche—and all the Sirins, who were made from the brain structures of the war dead—was...

Incidentally, while Vika wasn't connected to the captains of the Spearhead squadron via Para-RAID, their direct commander, Lena, and her staff were constantly connected to them.

"...Are they not aware that we can hear them? They speak recklessly, indeed..."

Frederica frowned as she listened to the teenage soldiers' chatter. It was a recon run where Shin had confirmed that the enemy wasn't around ahead of time. It wasn't the path they'd take during the operation, and while they were still vigilant, they

had the leisure to chat with one another.

They were in the Revich Citadel Base's surface sector. The base's data center still wasn't set up to receive the Juggernaut's data link, so they took command from here, inside Vanadis. Sitting in the commander's seat, Lena dropped her shoulders heavily.

"I swear... They may have a different chain of command, but who knows when someone from the United Kingdom might connect to the Resonance..."

At Vanadis's side, the Brisingamen squadron, led by Cyclops, was deployed, along with a single Barushka Matushka. With a long-barreled 120 mm cannon on its back, it was shorter than both Vanadis and a Löwe and had a bulky appearance supported by ten short, thick legs. It was armed like a demon's fortress, with two heavy machine guns and a launcher, and its white armor, like a snow-furred beast, and glowing blue optical sensor gave it the visage of the fuzzy monsters sung of in folklore.

It was a Feldreiß for sure, but certainly not one for which mobility was the main focus. This machine was planned with the unstable, hard-to-maneuver-in terrain of the United Kingdom's battlefield in mind, with the central strategy of lying in wait to destroy the enemy with a single strike.

The Personal Mark of a snake coiled around an apple was emblazoned on the unit's armor. Identifier: Gadyuka. Vika's personal Imperial unit, modified with communications equipment for command purposes and enhanced computation abilities. Sending the guest out alone wouldn't do, of course, so Lerche went with him and helped command the Sirins who were scouting out the path for the invasion operation.

"But I'm a bit surprised... I thought Shin and the others might feel some sympathy for the Sirins, given they're treated the same way they were..."

They, the Eighty-Six, who knew what it was like to be treated as parts of a drone and forced to battle.

But apparently, nothing could be further from the truth. Kurena's frank disgust was a radical example, but it held just as true for Theo's blunt attitude, and even for Raiden, who despite his overall indifference apparently had his own thoughts on the matter. Anju was sympathetic, if only just a bit. And as far as Lena

could see, the other Eighty-Six generally kept their distance from the Sirins, seeing them as unfamiliar, creepy machines.

"You wouldn't feel any affinity for dictators who led witch hunts or ordered the massacre of other ethnic groups, just by virtue of belonging to the same category of oppressor as them, would you? Being similar to another means not that you feel affinity or sympathy for them. To begin with, 'tis dubious if they are that similar to the Sirins to begin with... After all, did you not flinch away from the Sirins the first time you saw them for what they were?"

Frederica was willfully forgetful of the fact that she'd frozen in place when Lerche showed herself and that she'd remained rattled and silent until the conversation had ended. Lena smiled softly.

"...Yes. I suppose you're right."

"Things are as such... However, well..."

Frederica tilted her head.

"...this may well prove to be a good encounter for them."

As Lena looked down at her, Frederica looked up at the holo-screen with disinterest.

"Pursuing the question of what the Sirins truly are isn't relevant to the battlefield, but asking if the Sirins are human or not, and if not, what sets them apart? What are humans, truly, and what makes one human...? Those are all important questions they will one day have to ask about themselves."

"....."

Lena recalled that the Strike Package was formed to be in charge of attacks on important Legion holds. It was also to be loaned to other countries for aid. Dispatch operations had high mortality rates, and it was perfectly plausible the Federacy intended to use it as a propaganda unit to garner favors and debts from other countries when peacetime came.

However, at the same time, there was another possibility. The special schooling periods the Eighty-Six were given, which were superfluous, seeing as their role was simply to fight. The increased number of mental health personnel allotted to them and the thorough counseling programs they were offered. Even their headquarters was located near a large city.

All of those, along with being dispatched for other countries,

may have been a form of consideration on the Federacy's behalf. To show the Eighty-Six, who couldn't see past the current state of affairs to a future beyond the Legion War, a new world...

"What makes us human? Put another way, for what purpose do we live? Perhaps this encounter will be a fine opportunity for them to answer those questions."

A short time ago, the Spearhead squadron had received a scheduled message from Lerche, who was Resonated with the Alkonost recon unit. When connected to her, a dead person, the Resonance filled with a coldness that wasn't there for a normal human being. Perhaps this was part of the reason the Eighty-Six felt disgusted by the Sirins, because Kurena and the other squad mates were silent as Shin answered her.

After exchanging several reports and messages and concluding the report, Lerche suddenly said:

"Incidentally, may I ask you all something?"

"...? Yeah."

Shin nodded, and it felt as if Lerche sat up straighter in her seat.

"I have heard of the Republic's acts of barbarism and that you Eighty-Six have been given refuge in the Federacy following the Republic's fall... So why have you returned to the military? Did the Federacy ask you to enlist in military service in exchange for your citizenship?"

Kurena gave an immediate, sullen reply.

"We never fought because someone forced us into it."

Her tone was strong and severe, as if the very question irritated her.

"Not for the Federacy nor for the Republic's white pigs. Never. We chose this for ourselves. If we have to count the days until we're hanged, we'd rather fight, face death, and keep struggling on until the day it finally comes... Don't look down on us."

"....."

Lerche seemed overwhelmed by the force of Kurena's statement.

"My sincerest apologies. Think of it as the meaningless chirping of a bird

in the background and forgive me... However, in that case..."

Just then, the oscillation sensors in their legs picked up a reading. An alert window popped up, and after a moment's delay, they heard the heavy, hard sound of metal plates clashing. The sound of a Löwe's 120 mm turret. It came from the direction of the Dragon Fang Mountain invasion route. Right where the Sirins were on recon.

"They were detected. How careless...! Even though you gave them the enemy's initial positions, Sir Reaper...!"

The wails of the Legion skulking throughout the contested zones picked up in volume at once. Their presence—which seemed to become clearer when they were in groups—was colored over with programmed, hollow, yet vehement hostility.

And one of those screams, a battle cry from a unit that was still distant from here, stuck out to Shin. It was a particular war cry that always came before a set attack pattern. But the distance was too far, and what waited beyond the horizon was only the Legion's territories. Was it a Skorpion?

But if it was a Skorpion, it was too...

"...! All units, spread out and switch to your sub-weapons. Colonel!"

He called out the moment he realized what he'd just felt wasn't a Skorpion.

"We're entering combat... I predict enemy reinforcements. Warn the armored unit, too!"



Thirty kilometers from the front lines, in the Legion's territories. In a snowy field sitting within a forest clearing, the Legion unit drove the multiple plow-like shock absorbers attached to its legs into the ground and took aim. Locking all of its joints, it fixed its body to the ground and deployed the rails on its back, which stretched forward. The tips of these massive rails, which extended as long as ninety meters, aimed north, to the United Kingdom's front lines.

Ameise units that lay in wait climbed onto the rails. Instead of

their 7.62 mm all-purpose machine guns, they had 14 mm machine guns meant for engaging lightly armored units. Clinging to the rails, their legs attached to a shuttle that resembled a starting block, they crouched down as if bracing themselves. Purple lightning ran through the rails, like the slithering of a snake.

These rail-bearing Legion were, like the Skorpion and Stachelschwein units, a type that didn't appear on the front lines. But unlike those artillery types, they were special support units humankind had yet to counter.

And the development code given to these support types by Zelene Birkenbaum while they were being developed in the Imperial military laboratory was the Electromagnetic Launcher type—Zentaur.



Lena couldn't believe her ears.

"Combat?! Are you saying the enemies are flying over the recon force ahead of you?!"

Normally, one might suspect it was an ambush, but with Shin that was impossible. She could hear Vika clicking his tongue on the other side of the Resonance.

"Nouzen is probably correct. Another armored unit just ran into the enemy... What kind of trick are they pulling here?"

Marcel, who had been listening in, gasped.

"They're probably using some kind of launcher unit! Light units like self-propelled mines and Ameise are raining down on them!"

"Raining down...?! Ah...!"

Having realized what was going on, Lena clenched her teeth. She'd seen mention of it in the Federacy's combat logs. It was very rare, but there were records of airborne lightweight Legion units and a speculated, unconfirmed catapult-type Legion—the Zentaur.

Catapults were primarily used by aircraft carriers to allow fighter planes to achieve the velocity needed for takeoff in case the available runways were insufficient. They used pneumatic

pressure or electricity to kick attached aircrafts overboard.

It was a violent method, but this device boasted massive output, which allowed aircrafts carrying bombs to reach a velocity of three hundred kilometers per second. Using it to launch the lightweight Ameise or self-propelled mines, which were even lighter, was a simple matter.

Marcel's face contorted bitterly.

"We've been ambushed like this once during recon training when I was in the special officer's academy, together with Captain Nouzen and Eugene...a contemporary of ours from back then. There were many casualties. Even if they're only lightweights, they can be dangerous if they surround you all of a sudden."



Raising a roar inaudible to the human ear, the Zentaurs simultaneously activated the spear-like electromagnetic catapults on their backs. The shuttles kicked off, launching the Ameise, which weighed over ten tons each, and throwing capsules containing a platoon of self-propelled mines over the ninety-meter-long rails. As they reached maximum velocity at the tip of the rails, the locks were released, and the launched lightweight Legion took to the skies, igniting the rocket boosters that had been attached to them, and ascended farther into the air, leaving trails of fire and smoke in their wake.

They reached their necessary altitude in the blink of an eye and purged their boosters, which had concluded their combustion. Before gravity could pull them down into a fall, they deployed pairs of collapsible, disposable transparent wings. The planet's gravity, which ruled over all, took hold of them, but their spread wings caught the wind of their downward descent and transitioned into a glide.

Gliding across the frigid heavens, the Legion headed for their input coordinates, beginning their headlong descent to the frozen earth.



Detaching their gliders as they approached the ground, the Legion spread their legs and landed. The Ameise touched down on six legs while the self-propelled mines used their four limbs like animals as they spilled out of their capsules, which had cracked open upon being detached.

Snow sprayed about, and the ground rumbled as they spread out in the gaps between the trees. The Ameise, which were in charge of scouting, turned their composite sensors about when...

“—Fire.”

The moment Shin gave his order, the Juggernauts lying in ambush rose up and fired the machine guns equipped to their grappling arms. The Ameise and self-propelled mines were types meant for antipersonnel combat, and their armor was light—therefore thin—which allowed them to be easily loaded onto the catapults. The barrage of heavy machine-gun fire, capable of shredding an automobile’s engine to bits, reduced them to swiss cheese before their enemy-encounter alarm could go off.

Confirming that the ghosts’ wails had all died out, Shin turned his attention to the next predicted Legion landing point. Unlike the Skorpion types’ bombardment, which drew a parabolic curve, gliding allowed the Legion to control their trajectory and change their landing spots, making them harder to predict, but with this forest being the battlefield, the situation was different. Landing required a certain amount of open space, and this thick conifer forest, with its trees being hundreds of years old, didn’t have too many positions large enough to accommodate that. And so Shin, who could track their airborne trajectory, was easily able to predict where they were headed.

“Rito, direction 113. Michihi, just ahead of your squad... Gun them down as soon as they land.”

“Roooooger that.”

“Yes, sir!”

The biting sounds of heavy machine-gun fire reached their ears even through the thick veil of the forest’s trees. However, their numbers were too great. The Legion tended to deploy the inhuman strategy of using part of their forces as decoys while having the rest charge through. And soon enough, the Processors would be left without any options.

The Para-RAID triggered, as if to answer this dilemma, and Vika spoke to Shin. Vika was exceeding his authority by doing this, but no one cared. Not even Lena.

"Nouzen. We'll get rid of the catapults. Focus on the ones landing."

Shin could faintly hear the consecutive sounds of explosions booming in the background of Vika's voice. The sound of several howitzers, likely the citadel base's fixed defenses. Multiple voices—likely belonging to the catapults—suddenly fell silent. Realizing the howitzer fire had swept them away, Shin returned his focus to the enemies around him... Indeed, the United Kingdom military was quite organized. It wasn't for nothing that they held the Legion's progress in check in this mountain range.

"—Roger."

"—Gunner team to Gadyuka. Suppression complete."

"Remain on standby. Provide covering fire on demand."

"By your will."

Nodding at the artillery team's report, Vika turned his attention to his royal guard.

"Lerche."

"Aye, my lord."

She responded to him immediately, using the special communication device the Republic and the Federacy called the Para-RAID. The marching Sirins under her command switched over to his control. Usually, the number of Sirins Handlers could control ranged from a team of four to a company of forty. Vika, however, was the only one in the United Kingdom military capable of commanding a full battalion of two hundred at once.

"Show them."

"By your will, my lord," Lerche replied, seated within the cockpit of her Alkonost.

Identifier: Chaika. The faint monochrome light of the optical screen reflected in her unblinking green eyes. Those artificial eyes, which Vika had worked painstakingly hard on to make indistinguishable from a human's. Their structure and function,

however, were no different from a Feldreß's optical sensor. As were the ears she received her master's orders with... Though her senses of taste, smell, touch, and pain were nonexistent.

In the end, we are but clockwork forged in the shape of man. We are not human.

"Sirin Unit 1, Lerche—moving out!"

The Legion that evaded the interception and managed to regroup surged out of the dark forest like a wave.

"—Get them in a pincer attack...so they can't shoot in this direction!"

The Alkonosts sharply pounced from the gap between the trees, and at the same moment, Lerche's warning blared through both the wireless and the Sensory Resonance.

Regardless of that, Shin braced himself for the sound of the ghosts emanating from the Alkonosts. The sound of the final moments of the war dead whose minds had been taken away as they'd been subjected to anesthesia. The voices of the ghosts, who continued wishing and begging to be allowed to return.

It truly was too hard to discern, Shin thought with a click of the tongue. He couldn't tell them apart. Especially in melee combat, where friend and foe were chaotically mixed together. The Alkonosts were optimized for fighting on the frozen battlefield and deployed with an agility that ignored the snowy terrain, closing in on the Legion's front lines from three directions.

Like the Barushka Matushka, the Alkonost had five pairs of legs, except its legs were long and jointed. Its torso, to which the cockpit was attached, was so thin it felt doubtful it even had armor to begin with, giving it the appearance of a pholcid spider. It had white armor that let it blend in with the snow's shadows, but while it had the appearance of an ice sculpture, the 105 mm caliber short-barreled gun launcher it carried clashed with that impression.

Leaving the sharp, distinctive sound of steel claws stabbing into ice in their wake, the Alkonosts wove their way through the trees in small hops or by climbing up the thick trunks and running over the treetops. Their frames were apparently lighter than the Juggernauts', based on a design concept that placed emphasis on

high-mobility combat, similar to the Reginleif.

From both the rear and above the treetops, the frozen spiders descended like starved winter animals on the Legion as they turned to face the Alkonosts.

With the Zentaurs having been bombarded before they could launch the entirety of the airborne forces, all that remained was to sweep up the Ameise and the self-propelled mines, which had relatively low combat capabilities. And with their numbers lacking, they were no match for experienced Eighty-Six.

On the other hand, a detached armored force was struggling with the Löwe that rushed in to cover for the Legion.

"Captain Nouzen, a detached force broke through. Two companies in size, a standard formation of Grauwolf and Löwe types. Exercise caution."

"Roger, Colonel. We'll go in to intercept them... Kurena, cover me. Raiden, you handle this side."

"Lerche, take two platoons and join in. Learn from them."

"By your will."

The icons of the Juggernaut and Alkonost mixed unit started moving within Vanadis's main screen, and the battle with the two Legion companies began. Lying in wait in the flanks of the Legion's route and purposely letting the enemy vanguard pass through in order to strike from their side was one of Shin's established tactics.

The Barushka Matushka likely saw the battle unfold, as well, as Vika said over the Resonance:

"...I'm surprised. An all-purpose unit, and a manned one at that, doing this much."

His voice was clearly tinged with awe, to which Lena smiled wordlessly. The research team and the maintenance crew had done well with outfitting them for fighting in snowy terrain, and although the Eighty-Six's skills were no reflection of her own, it still made her happy to hear them being praised.

"Pilots capable of matching an Alkonost—a drone—in mobile combat are rare in the United Kingdom. And these were only hastily set up for combat in

snowy terrain... If time permits, I would like to have them instruct the Sirins. Since they can be replaced if they break, they have a tendency to compensate for lack of skill with recklessness."

"Thank you very much. But I was surprised, as well... Forty units sent out for recon and eight more for scouting. I can't believe you're controlling them all on your own..."

"Small, individual decisions are made by the Sirins themselves to some extent, though I have to be in charge of enemy priority and their advance path... I'm only giving slightly more detailed instructions than you did while commanding them in the Eighty-Sixth Sector."

"Are there any points of fault with the Reginleif, from your perspective?"

"I would prefer their snow-terrain equipment to be a bit more fine-tuned. We have a few days until the attack, so I'd like to take the time to have them modified... In fact, why don't we have the Eighty-Six use the Alkonosts? I wouldn't mind hearing their opinion on it, either."

Lena blinked at the unexpected proposal.

"Can Alkonosts be piloted by humans?"

"Why do you think the Sirins are made in human form? Without that kind of compatibility, we'd be in trouble in a scenario in which we were short on pilots or rigs. If a pilot has to forfeit their machine during combat, a nearby Sirin can hand over their Alkonost... Spending too much time on our battlefield can be taxing on the body, after all."

Those words were off-putting, coming as they were from the lips of this inhuman serpent, one of the rulers of the last despotic monarchy on the continent... Words that purely valued human lives.

"The battlefield is no place for humans to begin with. If possible, I would have Sirins piloting exclusively, but it takes some degree of aptitude to become a Handler... And soldiers have their own ideas of dignity and disgust. Though perhaps that is to be expected when they consider entrusting the United Kingdom's fate to these terrifying automatons."

That wasn't to say he grieved their loss, per se... But it was also somehow different from an owner of livestock lamenting the loss of his animals.

"...Vika. Can I ask you one thing?"

"Mm?"

"About Lerche. Why is she...the only one that looks exactly like a human?"

She had golden hair, just like a human's, and didn't have a quasi-nerve crystal embedded into her forehead. And while she served as an escort, she wasn't turned off and stored away in times of peace like the other Sirins. Rather, she freely walked about the palace.

"...Yes, well..."

For the first time, Vika spoke with an evasive tone.

"...My apologies, but can I abstain from answering that...?"

It was a clash of highly mobile armored weapons. As the machines rushed to evade being shot through the front in their attempt to gun the enemy down, it was naturally hard to tell friend apart from foe. The unstable, snowy battlefield put Shin's Undertaker, which was optimized for melee combat, at a disadvantage.

As such, he avoided melee combat and switched to recon duties. He would instead serve as a decoy, fishing out units that attempted to encircle his comrades. Waves of shrapnel, machine-gun fire, sniper shots, and bombardment crashed against the Löwe stampeding through the ice and crushing it under their feet, cornering and destroying the Grauwolf types that freely moved through the forest.

Standing at the Juggernauts' sides, the Alkonosts faced off against four squads of Legion, repeating the practiced tactic of isolating and destroying individual units. They were, after all, similar to the Reginleif in terms of being lightly armored, agile units, and like Undertaker, they were designed for close combat.

Using their short-barreled 105 mm gun launchers, which allowed them to fire HEATs and anti-tank missiles from the same barrel, they decimated the Legion with close-range bombardment.

However...

"—They're fighting like they know they're gonna be destroyed," Raiden whispered faintly.

Several Alkonosts that had had their legs blown off by

machine-gun fire clung to a Löwe, firing volleys into it like vultures clinging to an animal and tearing it apart alive. As a few Grauwolf types rushed in to assist, a single Alkonost stood in their way to delay them. Another clung to a Grauwolf that had followed it to the treetops, dropping them both in free fall, and another drew out the flock of self-propelled mines, only to rush at a nearby Löwe after they clung to it, blowing both the Löwe and the mines away.

It was different from the Eighty-Six and the Federacy's Vánagandrs, who faced the Legion by fighting in coordinated groups. The Sirins' fighting style was based around acting as decoys and stalling the opponent at first, then making suicidal charges in an attempt to take out chunks of the enemy force. And it was evident from their lack of hesitance that none of the Sirins had any reservations about the tactic. It was as if they had accepted the fact that they were expendable...

"They should really consider their application a bit better. If they get whittled down this quickly, we won't have enough hands on deck to survive the operation. Hell, even getting there might be hard like this."

"Yeah..."

Shin started replying but was suddenly cut off. Ahead to the left, at the edge of the trail disappearing behind a curve in the trees, his ability picked up that part of the Legion forces facing off against the Alkonosts had broken through their defenses. As he cast his gaze sharply ahead, two Löwe appeared on the trail. Löwe had low sensor capabilities. They didn't sense Undertaker's presence beyond the trees, nor were they wary of an attack from another direction, as their turrets revolved after only a moment's pause. But by the time their sights aligned his way, Undertaker was already upon them.

Using fallen trees as footholds, he advanced in small, sharp leaps, tearing through the first Löwe's flank as he passed it by. He then used his victim's legs as a foothold to jump away and evade the second one's shot, pumping a shell into the top side of its turret in revenge. The two Löwe crumpled to their feet at roughly the same moment Undertaker landed, surrounded by a spray of smoke and snow.

An Alkonost that had rushed after the Löwe appeared in his

optical screen, standing stock-still and staring at him. The Personal Mark emblazoned on it was that of a white seabird—Chaika. Lerche's unit.

"...Unbelievable. Truly, this is the prowess of the Eighty-Sixth Sector's Reaper... To think a human would single-handedly overwhelm a Tank class."

"Are there any Legion left over there?"

"Huh...? No, the rest of my unit swept them away. Our carelessness was a hindrance to you."

As she spoke, Chaika's faint-blue optical sensor restlessly turned to the fallen Löwe.

"I'm surprised you're okay. A human, riding such an unruly mount—"

"We're used to it," Shin replied plainly.

The fighting was so fierce they had to get used to it whether they wanted to or not, and those who couldn't—those whose bodies couldn't keep up—died, as they were unable to fight.

"Used to it,' you say... I see. The battlefield of the Eighty-Sixth Sector must have been harsh, indeed..."

She had no breathing functionality, yet she spoke with a sigh. Chaika's optical sensor once again turned to the Legion's wreckage.

"...Sir Reaper. If..."

She asked him a question in a voice as sweet as a warble. Suddenly, almost casually.

"If you could discard your human body and gain greater combat prowess, would you do it, Sir Reaper? For the sake of living on and continuing the fight."

For a moment, Shin didn't understand what she was saying. And the moment he realized, a shiver ran down his spine—a rare occurrence for one so apathetic.

"What are you—?"

"Your circulatory system could be augmented for greater pumping efficiency. Your legs could be modified with artificial muscles that would increase their shock absorbency to prevent blackouts. If your blood was made synthetic, you would see vast improvements to your oxygen-production capabilities. Currently, your internal organs are vulnerable to impact and ill-suited for the high-mobility combat we are accustomed to... All these modifications are possible with the United Kingdom's technology, though

many of the procedures are still in their experimental stages. The brain's fragility is one thing that is still beyond the reach of their technology, but we Sirins have overcome even that issue. Would you gain such power if you could? Would you claim it, to fight on?"

"..."

For the sake of defeating the Legion...it was a valid suggestion. The Legion overwhelmed humankind because they were machines built specifically to combat humans. Humans had many functions that were useless or even disadvantageous when it came to combat, and they couldn't hope to match the Legion, which were optimized solely for combat.

So if humans were to discard all their imperfections... If they were to rid themselves of anything that was not needed for combat and they were to cast aside the flesh and blood that were useless for battle in favor of more efficient machines, it would surely increase their chances of victory.

And still...even those with nothing to defend...nothing to gain... Even the Eighty-Six, who saw fighting to the bitter end as their sole source of pride, didn't wish to sacrifice their flesh-and-blood bodies for the cause.

Lerche smiled at Shin's silence. There was some mockery to that smile, but it was also mixed in with a faint hue of relief.

"—I've said something unnecessary. Please forget I mentioned this."

"You..."

Her smile grew thin.

"The enemy is approaching, Sir Reaper... Please forget this."

The Juggernauts and Alkonosts regrouped and soon switched to taking out the Legion's airborne forces. Shortly afterward, the United Kingdom's armored unit engaged and eliminated the Legion's armored forces. And at some point, in the midst of the combat that raged through the ice and snow...

"—You death-obsessed birds of prey..."

No one was there to listen when both a Processor and a United Kingdom pilot let slip the same words.

Upon hearing the sound of a ghost's weeping, as faint as the fluttering snow, Shin instinctively turned in its direction. What he found wasn't a crumbled Legion but the wreckage of an Alkonost. *It really is too hard to tell them apart*, Shin thought as he sighed, removing his finger from the trigger. As both the Legion and the Sirins were based on the idea of using the war dead, Shin couldn't differentiate between them.

Of course, the Juggernaut's IFF (Identify Friend/Foe) device would identify the Alkonost as a friendly unit, but it wasn't so easy when it was so badly trashed. Judging from the fact that he could hear the wailing, the Sirin inside wasn't dead yet. Did he have the leisure to take it out, though?

Confirming there were no Legion presently approaching their position, Shin opened Undertaker's canopy. Opening the Alkonost's canopy proved difficult, as it wasn't at the front of the machine but was set to pop open from behind. If one were to prioritize the front's armor—and the life of the pilot—it was perhaps natural, but something about the design honestly didn't sit well with Shin.

He input the shared emergency code into the number panel, and the canopy flung back, accompanied by the sound of compressed air being released. As he leaned into the cramped cockpit, he was welcomed by an assault rifle—a United Kingdom standard-issue 7.92 caliber. The Sirin aiming the gun apologetically lowered the barrel.

She was tall for a girl and had red hair in a shade that was too striking to be natural. Her name was, if he recalled correctly, Ludmila.

"My apologies, Captain Nouzen. I thought a self-propelled mine might have sneaked up on me."

Right. Since the canopy was located along the rear armor, if the enemy was able to wrench it open, they would end up taking the pilot from behind. The angles one could shoot in were limited because of the seat's positioning, and one wouldn't be able to react to the agile Legion in time.

"I can understand why you were cautious, so don't worry about it... Can you move?"

Ludmila looked at Shin's extended hand with surprise and then

smirked.

"We Sirins are like cogs in the machine. We don't require rescue. His Highness informed you of this, did he not?"

"It was my understanding that the situation was so grave that you had no choice but to team up with the Federacy... If nothing else, I would think your country was in no position to freely dispose of and replace something that isn't broken."

Ludmila's wordless smile deepened. Taking her slender hand, Shin dragged her out of the half-ruined Alkonost. She really was heavy, and the palm of her hand was cold to the touch. A silent reminder that the person he touched was not truly alive.

Apparently, her donor was a young boy. He continued weeping with a wordless cry, his voice different from the girl before Shin's eyes. A wail that begged to be allowed to pass on.

Like the Legion and the countless Sirins...and his brother's ghost, which was gone now, and his few comrades who still remained trapped by the Legion.

"...Or maybe..."

The question slipped from his lips before he even realized. A question Shin himself hadn't thought of.

"...the truth is, you didn't want me to save you?"

Perhaps she wanted to be left to her demise. To return to the death she sought. After staring wide-eyed at Shin for a moment, Ludmila broke into a large grin.

"Nonsense. My body is the sword and shield of the United Kingdom."

Her tone and expression were filled with pride. Those were words and emotions that Shin, being an Eighty-Six without a homeland, naturally couldn't understand. Some of the Federacy's soldiers likely wouldn't agree, either. To not only accept but take pride in the fact that she was born a tool was a difficult concept to fathom.

The pride of the inhuman.

"If we are to be destroyed, we would do so while taking the United Kingdom's enemies with us. It is for that reason that we chose to linger on the battlefield even after death."

...And yet, the ghost within her cried out a different wish altogether.

"It seems things are mostly taken care of. They should be retreating soon," Anju said, looking around the battlefield as signs of the enemy grew scarce. The overlapping trees blocked their view of the frozen battlefield. It appeared there was a large mountain river flowing from the other side of the forest to their left and streaming water to the area, as the rumbling roar of the water resonated against the cliff face.

This armed recon mission was only a deception meant to fool the enemy. It could be said that their objective was complete at the point when they made contact with the enemy and entered combat, and the knowledge that the Zentaurs were out there was valuable information.

"Are there remnants of the enemy here, according to Captain Nouzen's recon?" Dustin asked, piloting Sagittarius about ten meters away. He was the least proficient in the squadron and a Republic citizen, and he was currently teamed up with Anju.

Regardless, Anju shrugged. Shin's ability could share the Legion's positions to those Resonated with him, but it was meaningless unless they were near him. The positions of the ghosts they heard via the Para-RAID were only relative to his position. And in addition to that...

"I feel this is something all newbies have to hear sooner or later, but...you shouldn't rely on Shin too much. True, Shin's ability is so accurate it's scary... But that doesn't mean he can always warn all of us in time."

If the situation ever arose where we lost Shin... Well anyway, they wouldn't be able to fight if they relied on him too much. She would've been able to finish that sentence back in the Eighty-Sixth Sector, but here, the words caught in her throat. Back then, it had been certain they would be put to death within five years of their drafting. Back when their fate had been predetermined, their only choice had been to face it head-on.

But things were different now. She didn't have to say those words anymore. Nor did she want to. She didn't want to imagine her taciturn comrade's death—especially because of how often he seemed to defy it—because spoken words had the power to become reality. That was something she'd heard from Kaie, a comrade from the Eighty-Sixth Sector's first ward, who'd had her

neural network assimilated and had become a Black Sheep.

Dustin fell silent and then nodded in contemplation of what Anju had just said.

"...You're right. I'd bet the Captain has it hard, too, with us relying on him so much."

Anju's eyes widened with surprise, and then she smiled. Dustin was an excellent student—a valedictorian, in fact—who'd been asked to hold a speech at the Republic's founding festival. He was a fast learner and always thought a bit ahead of what he'd been taught. Still, it was surprising to see Dustin, a Republic citizen, worry for an Eighty-Six like Shin.

"That's right. Let's try not to burden him too much... Mm..."

Just then, something nudged at her sense of caution, which had been interrupted by the conversation. There was something at the edge of her vision, across the trees. Something just below the cliff... Was it some animal from the forest or perhaps...?

"I'll go."

"Okay... Be careful."

Sagittarius stepped forward in pursuit. Wary of any gunfire that might come its way, it cautiously peeked forward.

"———What...?"

"Second Lieutenant? Report accurately—"

"It's not a Legion. There's nothing of the sort around here. But..."

A feed of Sagittarius's optical sensor was transferred to her via data link. The footage was zoomed in automatically, owing to Dustin's gaze on it. It was a cliffside with a terrifying difference in elevation. The river was surging beneath it, and an imposing rock face, jagged due to being whittled by the glaciers for many years, loomed over from both sides.

And scattered near the cliff face were...

"Shells...?"

They were 120 mm and 155 mm tank shells. Only the circular bottoms of the shells were peeking out, arranged in spaced-out rows, buried into the ground. Since they still had their gunpowder, they hadn't been shot here as part of a test firing. Someone—likely the Legion—had buried it here for some purpose. But the moment she realized there was a string-like material attached to the fuse, Anju's hair stood on end. This was...

"Second Lieutenant Jaeger! Get down! Colonel, Shin, watch out!"

She'd reconnected the Para-RAID and shouted a moment too late. Something moved in Sagittarius's field of vision. A self-propelled mine that crawled through a gap in an uneven rock face recognized the presence of the Juggernaut, reached for the string—the fuse to the lined-up gunpowder—and held it close to its chest, stuffed as it was with high explosives.

"There's a trap in our path of retrea—"

The self-propelled mine self-destructed, unleashing shock waves and a blinding flash. The fire ran along the wire and to the shells' fuse, igniting and detonating them one after another. The strip of land they stood on—the frozen land of the conifer forest—collapsed within seconds.



It seemed the water swept them away for quite a distance.

They somehow managed to crawl up to a coast littered with fallen trees and sediment. As they opened their canopies, their Juggernauts were now half flooded. Anju looked over the rigs and sighed.

"...Are you hurt, Second Lieutenant?"

"I'm fine, one way or another."

It was a good thing they were piloting Reginleifs. With its design that cared little for the well-being of the pilot, the Republic's aluminum coffin had a gap between the canopy and the frame, as if to mock the very idea of waterproofing. If they had been piloting Republic Juggernauts, they'd have drowned or frozen to death by now.

Still, they weren't completely dry when they crawled out of the water. The sun had set while they were unconscious, and though the snowfall had stopped, the air was getting colder. Anju stood in the frigid air, looking around while sweeping away her hair, which was so cold it felt as if it might freeze over. They had to find somewhere, anywhere, to take shelter from the wind.

Having found a small log cabin situated at the riverside at the

bottom of a steep ravine surrounded by cliffs, they decided to take refuge there. It was probably a hunting lodge or something of the sort. A place set up to spend multiple days hunting through the winter mountains, it seemed.

The interior was a shabby but thankfully well-equipped single room, with a fireplace at the end of it. They were in luck.

"So we wait here for help to arrive?"

"We don't have much of a choice. The Juggernauts are out of energy, and we can't use the Para-RAID right now."

The temperature had fallen below zero, and RAID Devices were metallic. Touching them recklessly could cause frostbite.

"We can stave off the wind and snow here. I don't think we'll freeze to death... However..."

The thought of it made her sigh. Their cockpits had collapsible gunstock assault rifles, and they'd brought them along with the handguns in their holsters.

"...self-propelled mines aside, if any other kind of Legion show up, we might be in trouble."

"They're stranded."

"Seems like it."

It was a snowy mountain, albeit in summer, and they were a small number of isolated people. Not just Shin but even Vika, who usually remained composed in any situation to the point that it felt arrogant, had a severe expression on his face.

They were in the Revich Citadel Base's meeting room. They'd recognized that Anju and Dustin had gotten caught in the landslide, but they'd had to retreat to restock and out of concern for a counteroffensive from the Legion's territories. This emergency meeting had been called as soon as they'd returned to base.

Raiden, Theo, and Kurena were still in their armored flight suits and were prepared to set out and search for them as soon as their units were given the minimal amount of fuel and supplies. Lena's anxious expression and the severe look in Vika's eyes were because they realized the scope of the area from the terrain. They couldn't pick up the Juggernauts' signals from the depths of the

ravine they'd plummeted into, and the Para-RAID wouldn't connect. There was no way of confirming their survival at the moment.

It was then that Frederica rose to her feet, scoffing with a look of indignation.

"You lot seem to be forgetting something crucial, I believe. 'Tis at times like these that I show off my true worth."

"Your ability could let you see where they are!" said Lena when she realized.

"Indeed. Leave it to me, Milizé. I shall find Anju and Dustin's position within moments."

Puffing out her meager chest as much as she could, Frederica opened her "eyes."

However.

"There, I found them! This is....."

She fell silent for a long time.

".....Where is this?!"

Lena, who had been waiting with bated breath for Frederica to finish her statement, almost fell over from exasperation. Shin asked with a sigh, as if saying that he could see this coming, "Frederica, for now just tell us what you can see around them."

"Hmm..."

Frederica seemed to be looking around earnestly. Her small head turned to and fro with her crimson eyes glowing faintly.

"...I see snow! And mountains, too!"

Well, yes. This was a snowy mountain, after all.

"Can you see anything that sticks out, that could be a landmark?"

"Hmm, uh, they're in an old shack of some sort... There is a large tree to its right!"

Well, yes. That would be there, too.

Said shack was likely some sort of hunting lodge, but there were more than just a few of them in the area; it wasn't much of a clue.

"Can you see the stars?"

"I can, but it, hmm, doesn't really help me get a handle on their position..."

Figures.

"I guess you can't really recognize the North Star... Think you could find it if I explained how?"

"It's...hmm... There are too many stars, I can't really tell which is which..."

So you're practically useless.

Though maybe it's just natural she doesn't know, thought Shin—who had experience fighting in the mountains, in the snow, and in ambushes and had even been separated from the group and stranded in the past. Getting your bearings was almost impossible on a snowy mountain.

Incidentally, Vika had fallen over the table and had been twitching for a while now. Apparently, he'd been laughing so hard he couldn't speak.

"Roger. I guess we'll have to look for them ourselves, the old-fashioned way."

"My apologies..." Frederica dropped her shoulders dejectedly.

Shin patted her head in a completely unconscious gesture.

"You told us they're both fine and that you can see the stars... In other words, it's bright out where they are. If there was a blizzard around them, we'd never find them."

"...Right."

Finally recovering from his fit of laughter, Vika rose to his feet, his eyes still full of tears.

"That said, nights when the weather is bright are actually colder. They'll be in trouble if we don't hurry... We'll send over people from our side, too. We have to find them as soon as we can."

They'd carried the survival kits from their cockpits into the lodge, using the waterproof matches and solid fuel inside to light the fireplace, leaving them with nothing more to do but wait. Having taken off the top of her wet flight suit and covered herself up with the blanket from the survival kit instead, Anju stared into the fire, which still hadn't grown.

Getting lost and stranded on the battlefield was a common occurrence in the Eighty-Sixth Sector, and so despite having hurried to find a place to take shelter, she wasn't quite panicked

or anxious. It was just...

Anju grimaced. At the time...he was always there by her side, as he had been since the first squadron she'd been appointed to. And now he wasn't. Now he wasn't anywhere.

"...Second Lieutenant Emma?"

"It's nothing... Oh, you can call me Anju. We're the same age, right?"

Dustin had also taken off his top and covered himself up with a blanket. His silver eyes reflected the flickering flame. The silver eyes of an Alba. If only her eyes were that color...she and her mother wouldn't have had to be sent to the internment camps. The thought crossed her mind every so often when she looked at Dustin or Lena.

She didn't wish she could live within the walls as a white pig, and the comrades she'd met in the Eighty-Sixth Sector were irreplaceable to her. Yet, she couldn't ever say that her being driven out to the internment camps and into the Eighty-Sixth Sector...had been a good thing.

Her mother had looked almost entirely like an Adularia, and she'd tried her hardest to protect her daughter, who also was almost indistinguishable from the Adularia. But she'd ended up dying, ravaged by disease until she looked less like a woman and more like a tattered rag.

And the words the man who was her father had said. The words that hadn't faded to this day.

"Can I ask?"

The question slipped from her lips almost involuntarily.

"Why did you volunteer for this unit?"

He turned his silver eyes to her inquisitively.

"I already told you my reason. The Republic needs to wash away its sins."

"I don't think that's the only reason."

He had all the reasons in the world not to fight.

"..."

Dustin fell silent as he gazed into the fire. And just as Anju was about ready to forget the question, he started speaking.

"I'm an Alba, but I was born in the Empire."

Anju's eyes widened with surprise. Dustin kept his gaze on the

fire, not turning to look at her.

"I moved with my parents to the Republic when I was too little to remember it, and then we got citizenship, so I don't feel like I was ever part of the Empire. But originally, I was an Imperial."

"The place I lived in was a new town for first-generation immigrants. I was the only Alba in my elementary school, too. And then...the war with the Legion started, and everyone but me and my family was marked for the internment camps."

Dustin remembered it as he spoke. He'd thought everything had gotten noisy outside, but his mother, who had seen what was happening that night, told him he mustn't look outside no matter what the next morning. And the next day, when he went to school as usual...he was the only student left.

"It made no sense. Absolutely no sense. Look at Captain Nouzen—his parents were from the Empire, but he was born in the Republic. He was as much a descendant of the Empire as I was, but unlike me, he was born in the Republic...but they sent him to the internment camp and not me. It should have been the other way around. Their whole reasoning was that they were sending away people who came from the Empire, but it was just pretense. And it was just as true for everyone from school. It made no sense that I was the only one who stayed, that I was the only one who got to take refuge inside the walls."

All because Dustin and his family were Alba.

"So this wasn't someone else's problem to me. I always thought they had to be stopped... But it was too late, and I couldn't do anything in the end."

How long will this go on?!

That was what he'd shouted on that day, during the valedictorian speech at the Republic's founding celebration. On the eve of the festival, when none of the citizens had reacted to his words. The day the Legion had attacked and the Republic had perished.

"...I see."

Burying her face in her knees, Anju said nothing more. And Dustin could sense that this was all she could say.

Silence once again fell on the small hunting lodge sitting in the corner of the battlefield—a silence that was slightly more awkward than before. Incidentally, since it took time for the fireplace to light up properly, the air in the lodge was still cold. Hearing the small sound of a sneeze from beside him, Dustin turned his gaze to find his comrade rubbing her shoulders. Dustin took off his blanket and handed it to her.

“Here.”

As Anju simply blinked in amazement, he nudged it in her direction.

“Have two of them. It’ll be better that way... A woman shouldn’t let her body get cold.”

“...Thank you.”

But she paused for a lengthy moment because her long bluish-silver hair was still wet and would moisten the blanket if she put it on as is. She tied her hair at the back of her head and coiled it up tightly, stopping it from flowing downward. As she lifted both hands, her blanket and the collar of her undershirt slipped down a bit.

Dustin looked away in a hurry as the white of her skin, dazzling even in the dimness of the night, entered his field of vision, but then his breath caught as he also got a glimpse of the scar on her back.

Whore’s daughter, it read.

The question slipped off his tongue before he could stop it.

“Don’t you want that removed?”

The Republic had fairly advanced treatments for removing scars, and so did the Federacy. It might not be possible to completely erase it, but it could at least be made less conspicuous.

Tracing Dustin’s gaze, Anju smiled faintly. It was a slightly unpleasant smile.

“Oh. I’m sorry—it must look hideous.”

“Ah, no, that’s not it...”

He searched for a more delicate way to broach the subject. He opened his mouth while still in thought but couldn’t come up with anything, and eventually he simply said exactly what was on his mind.

“It looks painful.”

Anju’s expression suddenly shifted; she looked caught off guard.



"I mean, it's not like a scar that has sentimental value. So...you don't have to force yourself to bear it."

Anju blinked a few times at his unexpected words and then slowly smiled.

"...You're right."

It was different from the scar on Shin's neck, inflicted on him by his brother, which was important and precious enough that he would carry it even after slaying him, though he kept it hidden so no one would touch the mark of that sin...

"Right. Maybe it's time I had it removed. I'd like to wear open-back dresses."

Though she didn't want to cut her hair.

"And I kind of want to try wearing a bikini, too."

"A bikini..."

Dustin's expression stiffened, as if he'd just swallowed something solid.

"Is there, um...anyone you'd like to see you in a bikini? Or..."

Hearing that timid question put Anju in an impish mood.

"Why do you ask...? What, Dustin, do you like me or something?"

"Tha—"

Dustin held his tongue for a moment and then spat the words out, half in desperation.

"Y-yeah, I do! You got a problem with that?!"

Anju had said it only to tease him, but she widened her eyes in surprise at his unexpected confirmation.

"Huh...?"

"I mean, of course I do. You're pretty, and...and you always look out for me even though I'm an Alba. It'd be weirder if I didn't start liking you."

Anju went redder and redder with every word that left his lips. She turned away, unable to look straight at him, but Dustin continued his brave confession.

Just say it all. Take this chance and tell her everything, dammit!

"From the moment I first saw you, I've admired the color of your eyes, so if you're gonna wear a dress, I think it should match the color of your eyes."

With her face bright red, Anju hung her head in a fidgety fashion.

"Um... I'm, uh, I'm honored...?"

For some reason, her response came out as a question, which went to show how out of sorts she was. She buried her face in her knees to hide her blushing cheeks.

"But...I can't...I can't fall in love anymore."

Something about her tone sounded as if she was rebuking herself. Dustin looked daunted, as if he'd been doused with cold water.

"...Why?"

"I loved someone once."

"Nng..."

Loved. Past tense. And Anju was an Eighty-Six, which meant...

"He was a sweet person. I loved him, all the way to the very end... And no matter who I fall in love with, I know I'd never forget him. I'd keep comparing others to him. And that would be wrong, so I can't fall in love with anyone anymore."

Dustin turned his gaze to the burning fireplace again.

"I...I think that's wrong."

If nothing else, surely that.

"It's obvious that you wouldn't forget about him. Especially if he was a good guy. And if you can't forget, it's natural you'd keep comparing other people to him. But I think not being with anyone because you can't forget him... Because you'd keep comparing anyone you loved to him... That's wrong. Because if you do that, you'll...you'll never be happy."

Feeling her azure eyes fixed on him at the edge of his vision, Dustin continued, intentionally gazing into the fire. If she couldn't answer his feelings, then that would be that. But to bind herself into never loving someone again—into never knowing joy again—would be awful.

"So...even if you can't forget him...even as you remember him...I think you're allowed to find new things to love... At the very least, *I'd* never expect you to forget him..."

He looked back into her blue eyes, the color of the highest point in the heavens.

".....I came to get you guys," said Shin. "But it looks like I'm

interrupting something.”

Dustin and Anju bolted away from each other. Dustin slammed his head hard against a shelf attached to the wall, and Anju coiled the blankets she had drawn over her and turned away as she looked at him.

“Sh-Shin?!”

Shin stood at the entrance to the lodge, looking down at them with an incredibly cold glare Anju hadn’t seen him give in all the years she’d known him. He’d always had a habit of walking without making any sound. The small part of Anju’s thoughts that wasn’t running around in panicked circles made note of this. Apparently, that talent of his extended to other noises he made, too. Like opening doors.

“You two look like you’re doing just fine. Sorry for ruining the mood.”

“H-how long have you been there?!”

Shin paused to think before answering.

“Bikini.”

“So you were here pretty much the whole time! Nooooooo!”

Anju shrieked, cradling her head in despair. Leaving Anju to her agonizing, Shin turned to the door, looking up diagonally. His Juggernaut was sitting at the top of the cliff, and apparently he had used a wire to descend.

“Fido, looks like they don’t need our help. Reel it up.”

“Pj...?!”

“Ah, wait, wait, wait, Shin! Don’t go! Help us!”

Fido’s panicked beeping came at around the same time Anju desperately begged him to stay. They were still in the Legion-infested contested territory, and anyone would probably be a little pissed to find the friends they’d searched through the cold, dark night for indulging in carefree romance.

Thankfully, Shin was only joking, and after he gestured something to the Scavenger with his hand, Fido dropped an object, which Shin then tossed in Anju’s direction: a military uniform sealed in waterproof vinyl packaging. Everyone else had probably been worried that the two of them would be cold and wet.

“Thanks... Sorry.”

"It's fine."

Fido then dropped another prepackaged uniform, but when Dustin reached out to accept it from Shin, he was instead forced back when it was slammed against his face. The bundle of clothes crossed the space between Shin and Dustin despite not traveling well through the air and slammed into him with a merciless, full-force pitch.

Only raising his chest, Dustin moaned.

"Hey, what gives?!"

"That was from Daiya. If you make her cry, I'll feed you to the Legion in his place."

That response, as neutral as Shin made it sound, caused Dustin to swallow any words of protest he may have had. It was the first time he'd heard the name. But judging by the situation, he obviously knew whom Shin was talking about.

"—All right."

Anju, on the other hand, went red again at their exchange.

"W-wait, Shin... I—I didn't forget about Daiya or anything, and it's not like I, um, fell in love with Dustin, so, um..."

He may not have known her as long as Daiya had, but Shin had still spent a long time with Anju. He was like family to her. And while she didn't really care what he thought of the current situation...she didn't want him to think she was loose or fickle.

As Anju panicked feverishly, Shin shrugged and turned around.

"I don't know about Dustin, and this isn't something to talk about when he's present to hear it... But it's been two years since Daiya passed away. I don't think he would've wanted you to stay chained up like this."

Those words made Anju break into a tearful smile. He was always so optimistic, so softhearted...so *kind*.

"...You're right. He probably wouldn't have, but...but..."

"...I can't. Not yet."

As she whispered those last few words to herself and a tear slid down her cheek, Shin, who had turned his back, and Dustin gave her what little privacy they could afford.

Incidentally, Shin had kept his wireless on the whole time, so

everyone who was out on the search overheard the two's conversation starting from the bikini part. After returning to base, Dustin was subjected to what felt like an endless stream of teasing by Raiden, Theo, Kurena, and Shiden.

"...Snow Witch and Sagittarius were just recovered, too. They'll be going into repair and maintenance as soon as they're delivered back to base," said Vika, relaying a report he'd likely just received via Para-RAID from the recovery team.

"As a result of the maintenance required for the Reginleifs sent out to search for them, the Dragon Fang Mountain operation three days from now will probably be delayed by two to three hours."

Lena sighed in relief.

"...Thank goodness. But I'm sorry..."

"Don't let it bother you. The operation is planned for three days from now. Two to three hours is within an acceptable margin of error... And now that they're back, we know about the landslide trap. We've sent Sirins to investigate, and apparently the Legion have those set up at every possible route within the contested zones. Two of them are along the route the Strike Package would have taken during the operation."

Lena's expression hardened. If they hadn't noticed, the whole unit could have had its path of retreat cut off. Unlike a normal mine, this trap didn't respond to heat, sound, or oscillation detection. It would be hard to find without triggering it. Those bombs were difficult to detect thanks to their being hidden under thick frozen rock, aiming to destroy not the Feldreiß themselves but the terrain. The trap's only flaw was that it required a self-propelled mine to trigger—and the Zentaurs made it easy enough to spread them out without anyone noticing.

"Digging them all out would be difficult given the amount of time we have, so for the time being, they're removing the strings and fuses and covering the whole trap in flame-retardant resin. It's only a stopgap measure, but it should do for the operation's duration."

"...Doesn't it strike you as strange?"

Vika's violet eyes shone at Lena's cautious utterance.

"It does."

"These are contested zones where the forces of the United Kingdom and the Legion clash. Setting up traps along all the routes Feldreß would likely pass through is possible. But during today's battle, the trap didn't trigger until Second Lieutenant Emma noticed it. Which means..."

They didn't use those traps for disruption when Barushka Matushkas and Juggernauts entered and retreated via those routes... These weren't traps set up to defend the area.

It was as if...

"...As if this was meant to lure our forces deep into the territories and trap them behind enemy lines."

"And the chilling of the weather using the Eintagsfliege might have been a part of that plan."

"...It's possible. With them strangling us slowly like this, the United Kingdom military would have no choice but to mount a counteroffensive sooner or later. And we'd send in elites to do it, too. Now that the Legion have enough heads for their standard units, they would start seeking out better prey."

Vika then fell silent for a moment before shaking his head lightly.

"—We need to make some preparations. I'll reinforce our reserve residual forces, just in case the worst-case scenario hits. That way we'll have someone to send over to rescue soldiers trapped on the battlefield."



He should have gotten used to it by now, but for some reason he had to gather much more courage than usual. Both to connect the Para-RAID and to say this one sentence.

"Lena, could you come out with me for a bit?"

Somehow, he'd silenced the bashful anxiety from his voice and feigned his usual tone, but he didn't realize that he'd unconsciously done it, much less why he'd done it.

The Revich Citadel Base's observation tower was built over the remains of a castle tower dug into the mountain supporting the canopy covering the base. An overly steep, clockwise spiral staircase made up the long trip to the canopy, where there was an observatory for tracking the enemy's movements. Standing at the top of the highest base in the region gave one the impression they were sitting on a swan's back.

At the circumference of the wings, antiair autocannons and antiground, antiair sensors were set up, cutting off the view of the night sky. Even this spot, elevated as it was with a distance of several hundred meters to the surface, didn't allow one to see the ground unless they stood at the very edge of the canopy.

Standing there as if floating in the night sky was Shin—who had called her here—clad in the Federacy's standard-issue trench coat, waiting for her to arrive. It may have been late spring, but it was a snowy battlefield. Such a windy spot must have been very cold indeed.

"And up... Oof..."

Shin could hear the sound of the blast hatch leading to the inside of the observation tower opening with a small heave-ho, and the scent of violet flowers, which could never bloom in the snow, served as a precursor to her arrival. It was a scent he'd grown used to over the last two months... The scent of Lena's perfume.

"—Shin? Why did you call me all the way out here? Is anything wro—?"

Lena's question broke off, and Shin could hear her gasp even from a distance. A "Wow..." of amazement escaped her pink lips. She lifted her gaze up naturally, following that sight; countless stars filled the night sky, illuminating it with brilliant light. The sun that usually obfuscated them had sunk, and the night sky was clear of the Eintagsfliege's silvery clouds.

It was a dazzlingly beautiful starry night.

Countless stars she didn't know the names of were scattered about the velvety-black heavenly sphere like sparkling lights. A white galaxy and swirling nebulae filled the sky from one edge to the other in a slant.

It was a night on a battlefield removed from human cities, thus

lacking artificial light. The night sky was dark and black, which made the starlight and the luminescence of the snow stand out that much more.

The light spilled faintly over the canopy, which retained its whiteness even after years of being scraped and eroded. A thin crescent moon lorded over the scene from near the sky's zenith, looking down at them like a frigid queen.

Bending her neck back as far as it would go in her attempt to look, Lena almost fell, so Shin caught her by the arm and had her grab onto the fence set up to prevent people from falling off the tower for support. Without even noticing what was happening, she simply staggered forward as he pulled her, the starlight reflecting off her silvery eyes.

After standing dumbfounded for a few moments, she gave a small "Ah" and exclaimed with a sigh, "...It's gorgeous!"

"Yeah... You spoke about this with Kaie once, right? About how you can't see the stars from the First Sector, so you wanted to see a starry sky."

Shin shrugged as she gazed back at him.

"Unfortunately, I couldn't arrange a meteor shower for you, but...I thought of this while we were looking for Anju and Dustin. The stars were so bright."

For Shin, the battlefield's starry sky was a regular view, but he did remember the conversation Lena had had with Kaie back then. It was at the Eighty-Sixth Sector's first ward's first defensive unit's old barracks... Back when they thought a time would never come when they'd be standing in the same place together.

"So this is what you wanted to show me?"

"Is this uncalled for?"

"Not at all..."

Laughing innocently, Lena turned her silver eyes to the starlit sky again. Her hair fluttered in the breeze, shimmering against the view. When she'd left the Republic, it had been early spring, so she hadn't taken her official winter gear with her. Clad in a Federacy trench coat, she smiled as she recalled how quick her dispatch had been.

"This was definitely one of the nice things about living in the Eighty-Sixth Sector, right?"

Lena smiled, reminiscing on the words that Eighty-Six girl—who was now gone—had told her two years ago. She had always thought the Eighty-Sixth Sector was hell on earth, a battlefield only the Eighty-Six were pushed onto. And she'd never thought she'd come to hear those very same trapped souls say that there were good things to be found there.

Even though she wasn't in the same place as them. Even though she didn't know their faces or even their names at the time.

She sneaked a glance at Shin, who was also looking up at the sky silently, in contemplation of something. It was hidden behind the tall collar of his coat so she couldn't see it right now...but the decapitation-like scar was still there.

Lena had never asked him about the origins of that scar. She didn't know Shin well enough, and judging from how she didn't intend to ask and how he wouldn't speak of it himself, the distance between them was likely still considerable. They were at the same place, standing on the same battlefield...but that distance remained.

Well, you've only just met him.

It was like Grethe said. They'd only just met, and they'd only recently learned each other's names...and finally, each other's faces. But she still thought, somewhere in her heart, that they understood each other on a deeper level. As she looked up, she called to him.

"Shin."

"Lena."

Somehow, they called each other's names at the exact same time.

For a moment, they both stumbled over how to continue. Neither could decide how to react to the other, and an awkward silence fell over the starlit observatory. Shin recovered first and said, "...Go ahead."

"I'm sorry..."

Since the wind had been taken out of her sails, she had to muster up the courage to speak again.

"...About what happened back then."

She could faintly feel his guard going up. Apparently, that argument had gotten to Shin. Somehow relieved by that fact, Lena pressed forward.

"I'm sorry. I went a little too far."

"...It's all right."

"But I really am sad. That's one thing I won't take back. You all left the Eighty-Sixth Sector and were set free from that fate of certain death. Or rather, you should have been—but you've only just been set free."

They'd finally escaped the battlefield where their only freedom had been to decide where and how they'd die—but they were still standing on that same battlefield. To say that fighting to the bitter end was their pride was, indeed, the only identity they could cling to. And now that they were free to wish for more, they simply didn't.

They could go anywhere. They could become anything they wanted. They were free.

But they still couldn't find it in themselves to think of their own futures.

"The things that were taken from you are still lost, so you won't wish for the same things in the future. You can't tell which future you should aspire for. And that thought... It makes me sad."

You're allowed to wish for your happiness now. You're allowed to remember the things that were stolen from you.

Just like Vika, Shiden, and even Grethe had once said, telling the Eighty-Six to wish for those things when it was her side that took them away to begin with was incredibly arrogant of her.

It was like telling them that she opened the door to their cage, so they should come out. That they were free to go wherever they wanted...so she wanted them to come to her.

But Lena continued. And looking back, she realized those were words she should have told him last time.

"I think the reason you all gave up on the world is because you're all just...that kind."

"...Kind?"

"Yes."

"Just as you said, I honestly... Yes, I honestly don't care for the

Republic or the Federacy... I don't think you can call that kindness."

But Lena found herself smiling. She didn't think it was possible, but...

"Don't tell me you haven't noticed, Shin... You're a good, kind person. If you weren't, you wouldn't have carried the memories of all those people who died with you. You wouldn't have tried to free your brother, Kaie, and all the comrades who were stolen from the Legion."

"....."

"You are a kind human being. And so are Raiden and Theo, Kurena and Anju and Shiden, and all the other Eighty-Six. Because choosing to hate would have been that much easier. It really was the Republic's fault, so pinning all the blame on them and hating them would have been so much simpler. And still, you all...tore into your own hearts. You scarred yourselves so you wouldn't have to condemn the rest of the world."

With their own hands, they'd shed the memories of happiness, reducing them to dust.

"...Because cursing it all would have meant losing everything."

Even the last remaining bit of pride they had.

"Yes. For you, those very scars were your pride."

No matter how much would be taken from them and how hard they might be trampled, their sole pride was to never become as despicable as their oppressors.

"And I'm not telling you to lose those scars. But...I want to see your kindness rewarded," said Lena as if speaking to herself as Shin looked up at the starry sky. As if challenging the harsh world, which didn't allow for people's lives. As if proclaiming:

"Those who are kind are entitled to be happy. Those who are just ought to be rewarded. And if the human world isn't made that way right now, then I want it to be that way... Because that's how people make their ideals a reality—little by little."

May this world be a just, kind place. One day.

Shin remained silent at those songlike words of proclamation. It was an ideal that could never come to pass. It was just a wish, a

pipe dream that reality would never allow to come true, its beauty being its sole saving grace.

But even though that was his opinion, and as easy as it would have been to disregard what Lena had said, for some reason he couldn't put those thoughts into words.

The sea.

The words he'd said six months ago in that snowy military graveyard surfaced in his mind. He wanted to show her. Show her all the things they couldn't see now. That was his reason for fighting now. And now, even knowing that the world Lena wished to see was one that didn't and wouldn't exist anywhere, Shin couldn't bring himself to deny it.

"I'm sorry. I steered this conversation in a weird direction. You were trying to say something, too, weren't you...?"

".....Yeah..."

With the wind taken out of his sails, he had to drum up the courage to bring it up again. Right, what was it that he'd called her here to say? Before they set out for the Dragon Fang Mountain operation—before they found out if the information they'd glean at the end of this operation would change everything for better or worse.

"Lena, if the Federacy and the United Kingdom suspect the Merciless Queen is Major Zelene Birkenbaum, and she knows some method of stopping the war..."

And that likely wouldn't happen. Contrary to his words, Shin held no such expectations of Zelene. The war likely wouldn't end. But if it could...

"If this war really is going to end...when that happens—"

Suddenly, his words cut off.

Let's go to the sea. If possible, let's go and see something we've never seen before. Together.

He thought to say it. He'd heard Lena say that she wanted to see the ocean, but he'd never relayed those words to her. He wanted to tell her. And that alone could never be a lie.

I want to show you the sea. That's my reason for fighting now.

But just as he was about to say it...self-doubt rose from his heart like soap bubbles freezing in his throat.

I want to show you the sea. Not a battlefield where I die

without truly accomplishing anything. I want to show you something other than this world, ravaged as it is by the fires of war. I can finally wish for this.

But then what...?

What comes after I show her the sea? What would Lena wish for then? What would she let me wish for then? And how long would it last?

Shin himself didn't wish to see the sea. That hadn't changed. There was *nothing* he wanted for himself. And the emptiness of that was incomprehensible to him. He reflexively stopped thinking about it, but the doubt lingered.

To fight is the pride of the Eighty-Six. But if that was the case, if they were to fight on and survive...

CHAPTER 3

DEAF TO THE SONGBIRDS' LAMENT

Catastrophe struck all too suddenly.

“Tch...!”

As their armored transport vehicle was advancing deep into the contested zones, Shin picked up on that sound and raised his eyes. They were currently en route to the Dragon Fang Mountain capture operation. The United Kingdom military’s armored corps had commenced the diversion operation the night prior, successfully drawing out the Legion’s units, forming a gap on the battlefield.

In the distance, a new group of Legion was on the move. But the route they were headed on was odd. They moved neither in the direction of the enticement force nor in the direction of the Strike Package. The moment Shin realized an indistinct, artificial howling was mixed in with those forces, he was filled with an ominous premonition and activated his Para-RAID.

There was no logic to the warning bell that went off in Shin’s mind, only the warrior instincts honed by years on the battlefield.

“All units, hold your position. Raiden, you’re still at the base, right? Stay where you are.”

“Ngh, roger.”

“Captain Nouzen? What’s...?”

They were a brigade: a line of several hundred vehicles. Along with Raiden, who’d stayed behind to secure the rear, there were still several squadrons left dozens of kilometers behind, waiting for their time to head out of the Revich Citadel Base.

Raiden realized something was wrong and replied immediately. On the other hand, Lena wasn’t used to Shin’s ability, and her reaction was frustratingly slow. The Legion forces who were supposedly being stampeded and destroyed by the United Kingdom’s enticement force were turning the tide and pushing back. Legion were moving in from the depths of the territories, closing in on the United Kingdom’s forces, and beginning invasions of the United Kingdom’s own territories.

They were feigning retreat and circumventing the United Kingdom’s forces to invade.

We were the ones being baited!

As if matching the mechanical wailing, the Legion’s screaming picked up in volume, coming from a position distant from any unit, be it the United Kingdom’s or the Strike Package. A shout reminiscent of a Skorpion’s, but one Shin knew belonged to a different type.

And as that all-too-quick shout drowned everything out for an instant, Shin futilely traced its trajectory—delivering a warning that came far too late.

“It’s pathetic that we failed to respond in time despite your warning, but...I’m sorry, Nouzen. The Revich Citadel Base has fallen.”

They had shut themselves in the depths of the command ward, which was now dark due to their having shut off most of the electricity. This was the Revich Citadel Base’s underground command ward. It was in the fourth underground level—the lowest one—and had been built to be partially independent from the other wards. Vika spoke from the command post situated at the center.

The composite sensors set up on the outer circumference of the canopy in the highest level of the base were still functional.

The command personnel eyed the luminescent view of the snowy scenery before them with strained expressions. The Processors stood silently in steel-blue uniforms, as did the silver-haired girl clothed in Prussian blue who served as their master.

The few base personnel and maintenance crew members who had survived were sealing the corridors' bulkhead partitions while the Handlers stayed behind in the control room.

"To be more exact, they wrenched the base's functions away from us. The entire surface sector and eighty percent of the underground sector are under enemy control. The only parts under our control are the command ward and the eighth underground hangar, the lowest one. Currently, we're holing up in the command ward with all our lockdown mechanisms activated... Oh, all the Federacy soldiers successfully evacuated to the ward as well, so you have nothing to worry about in that regard." He added the last part after remembering he was speaking to a soldier affiliated with the Federacy.

Shin, who was currently on the snowy plains ten kilometers away from the citadel base's walls, replied without a hint of discomposure.

Being an Esper with an ability to pinpoint the locations of all the Legion on the battlefield, he already had some grasp on the situation, but he hid his anxiety regarding the survival of his comrades still in the base.

"It's as much my blunder as it is yours. It never occurred to me that they'd be able to launch the Phönix given the Zentaur's estimated specs."

Even with that warning, *what* attacked them was undetectable to both the radar and their optical sensors, so their inability to do anything was perhaps unavoidable. Shin and Vika weren't directly linked in the chain of command, and that brief lapse in communications brought about ruin.

It apparently landed atop the canopy protecting the base. The set anti-air/anti-cannon radar failed to detect its presence, and so anti-air autocannons could only fire blind barrages in odd directions. When those were destroyed, the alarm finally went off, and shortly after that, the hatch connecting the canopy to the

observation tower was ruptured from outside. *It* invaded, and the base's defensive forces were ordered to dispatch to the observation tower upon receiving news of the attack, where they encountered it—and were one-sidedly slaughtered.

It traveled freely through the citadel base's cramped corridors since no one was capable of seeing its form. Picking up on the situation, Vika operated the installation's buckshot mines manually and successfully stripped it of its optic camouflage, revealing its shape. Within the flock of destroyed Eintagsfliege appeared the form of a black Legion.

The High-Mobility type, Phönix.

At that point, the observation tower had already fallen. The base's defensive forces were cut in half, and taking advantage of the ensuing chaos, Legion airborne forces descended on the canopy, whose autocannons had been destroyed, and began invading the watchtowers.

Upon receiving those reports, Vika ordered that all surface and underground sectors, with the exception of the command ward, be abandoned. The corridors leading to the surface were systematically blockaded via bulkhead partitions, and all surviving personnel and Feldreiß were evacuated to the command ward and eighth hangar respectively, entering a state of protracted war with the Legion unit, which suppressed and took over the rest of the base.

After hearing the summary of the situation, Shin sighed.

"What the Sirins encountered during our earlier recon run was an enemy recon squad... If there's a suitable path to invade the Dragon Fang Mountain base, it means it can also serve as an invasion path for them. I...should have picked up on that. Not to mention our current situation."

A single-soldier invasion rush on the enemy base, executed by way of the Zentaurs' launching. It was fundamentally an impossible tactic. The cruising speed would be too slow, and the gliders would greatly increase the unit's silhouette, making it easier to detect. In addition, the Zentaur's launching limit was an estimated ten tons... Which meant it was capable of launching

only self-propelled mines and Ameise, which wouldn't be able to seize control of a heavily protected base.

But if the Zentaurs were to launch the Phönix, which was lighter than the Ameise, possessed more combat potential than the Grauwolf, *and* employed the Eintagsfliege to reflect all light and electronic waves...it would result in the perfect surprise attack.

It was an unprecedented assault. Yet, all this information was known beforehand. They could have predicted this.

"—Analyzing and predicting the enemy's tactics is my...the commander's job. You shouldn't let this bother you, Shin."

A thin, silver-bell-like voice joined the conversation, and Shin found himself gasping inaudibly. Lena. He'd only just heard that everyone had evacuated in time, but...

"This shouldn't be bothering you either right now, Milizé... And I get the feeling this is something none of us could have done anything about. It may have been technically possible for the Legion to do this, but this base doesn't have enough tactical or strategic value for the Legion to attempt it, and neither Nouzen, myself, nor you have lived through a war where one is attacked from the sky."

The Legion didn't employ aerial weapons. And while Shin and his group, who knew nothing but the war with the Legion, understood that the sky could be a route of invasion, they had never truly perceived it as such. And those who did remember a war that made use of aerial weaponry—the regular soldiers—died in the war.

After heaving a single sigh, Vika continued.

"Now, then. Since you can hear them, I imagine you have some grasp of the situation, but I'll explain it. Firstly, there likely won't be any further launching of Legion airborne troops. Our military artillery annihilated the Zentaurs, and all other possible launch points are within their range. They'd be taken out as soon as they were to launch any more forces."

According to the Federacy military's estimates, the Zentaur's launching range was an estimated thirty kilometers, which just fit into the howitzers' effective firing range.

"Next is our army's status. The enticement force we sent into the Legion territories was intercepted and wiped out. On the other hand, the Legion

forces that invaded our territories are currently being stalled by divisions of our remaining corps."

Shin furrowed his brow.

"...Wiped out?"

Even if they had been complacent due to the advantage of strong defensive facilities and an advantageous geographical position, these were still the soldiers of an army that had pushed back the Legion for over a decade. They weren't so weak that they would be wiped out simply because they fell into a trap.

"According to the final transmission the commanders who encountered them sent, the Legion had a concentration of heavyweight types hidden in the depths of their territories. They encountered an armored unit consisting of Löwe and Dinosauria."

Shin closed his eyes involuntarily. Dinosauria, of all things. This type was a metal monstrosity with an immensely powerful 155 mm tank turret and a massive frame with a weight exceeding a hundred tons, coupled with unreasonable mobility. If they were up against a group of those machines, which no Feldreiß in existence could match up to...Shin could easily imagine those forces being crushed like ants.

"They were likely mixed in with the supply lines from the rear and gradually switched places with the lightweight types. Which would mean the Legion have been planning this operation for a long time."

Shin's ability allowed him to trace the numbers and positions of the Legion but not to distinguish between their types. This meant that if they were switching their forces deep within the Legion's territories under the Eintagsfliege's jamming, it would be impossible for him to know.

"Military headquarters was informed about the base's situation, and they have reserve forces prepared to set out at any time, but the corps themselves are surrounded by the enemy, too. Apparently, it'll take at least five days for them to break through the enemy and reach the base."

"....."

In other words, the situation was that both the Revich Citadel Base and the Strike Package were currently cut off from their friendly forces, isolated, and surrounded by the enemy.

"...I've got bad news from our end, too. The Legion armored

units that wiped out the enticement force are headed for Revich. Their numbers are estimated to be eight thousand. What's left of the enticement force is trying to stall them, but they won't last long. Even adding in the time they'd need to regroup and restock...they'll reach the base tomorrow."

Vika heaved a deep, utterly unpleasant sigh.

"Yes, I figured this might be the case... Your ability's tendencies to smother any prospects of wishful thinking can be unpleasant at times like this. A Cassandra that can only make ominous but accurate prophecies will only be met with hatred and scorn."

"The Legion in the base right now number roughly one thousand..."

"Enough."

Shin ignored Vika's dejected plea and continued.

"I think most of them are self-propelled mines, but...what else was there? Just Ameise?"

Those were the only types they'd seen being launched in.

"As far as what the cameras that still function can see, yes... But we've confirmed they've also launched in multiple impact-buffered containers. We don't know what they contain at present. If we're allowed to be optimistic, they're just ammunition and energy packs."

"No way of sending out scouts, is there...?"

"Sorry. The upper underground sectors are under Legion watch, and any scout would be taken out before they could make it to the surface."

"How long until they break through the command ward's partitions?"

"They may be old, but they're still made for siege. You've got nothing to worry about...is what I'd like to say, but we'll hold on for now."

"We've got the Brisingamen squadron and the four squadrons led by First Lieutenant Shuga with us. They should be able to hold the fort... Don't worry."

Hearing Lena be concerned for him when she was in no position to worry about anyone else seemed odd to Shin. She and the others back at the base were the ones who were in the most danger right now.

"I understand the situation... So what do we do?"

Vika scoffed.

"Isn't it obvious...? There's only one thing to do."

Shin felt a cold smile spill from the other side of the Resonance. A slightly bitter smile, mixed with equal parts fear and ferocity.

"We hold a siege battle."

Owing to the Strike Package's armored unit's nature of being a dispatch unit and to most of its combatants being Eighty-Six who were familiar with fighting only in a squadron-size force, it was divided into a special structure of fourteen battalions, consisting of squadrons as its basic units.

The battalion captains were, excluding Shin, who served as the total commander, the fourteen most veteran members, including the Spearhead squadron's lower-ranking officers and Bernholdt, the oldest noncommissioned officer. The Sirins' representative was Lerche, and on the other side of the Resonance were Lena, Vika, and Raiden. The battalion captains had set up camp in a forest overlooking the Revich Citadel Base and were currently in an armored vehicle's container, which served as an impromptu conference room.

In hindsight, Shin realized that Anju and Dustin becoming stranded three days ago had been a stroke of luck for them. Searching for the two of them had delayed their maintenance time, and as such, their departure had been postponed from early this morning. If that hadn't happened, Raiden's group would have left the base before the Legion's attack, making it harder to defend the side that remained besieged. Also, their noticing the trap had allowed them to disable the other ones ahead of time and prevent their path of retreat from crumbling behind them.

Shin looked over a map of the battlefield laid out on a collapsible table and overlaid with a transparent cover, which detailed both their positions and the enemy's, as the fourth squadron's captain, Second Lieutenant Yuuto Crow, whispered, "... This is the worst possible situation."

Their main base had fallen, and they were isolated in the middle of enemy territory. Friendly reinforcements would arrive only in five days at the earliest, and the enemy's reinforcements

would arrive sooner than that...

"According to your recon, the Legion's reinforcements number eight thousand troops, set to arrive tomorrow at the latest... Which means tomorrow we'll be pressed between the base's walls and two heavily armored units of eight thousand Löwe and Dinosauria."

"Our forces number six thousand, counting the Alkonosts. And on top of that, the Phönix even Captain Nouzen couldn't beat is sitting inside the base..." Second Lieutenant Reki Michihi's tone was rife with suppressed anxiety as he continued, "Since they've got us beat in numbers, we should avoid fighting them on two fronts... Should we set out to engage the enemy's heavily armored units and try to destroy them or force a retreat?"

"Quite the opposite, Second Lieutenant Michihi. We can't focus on intercepting the heavily armored units."

Michihi's eyes widened at Lena's response from beyond the Resonance.

"Defeating the enemy's reinforcements would be meaningless if our goal is to overcome this situation. It would contribute little to our goal of breaking the enemy's siege. We wouldn't just be whittling down our forces for naught—it would also prompt the Legion to send in more forces."

Rito knit his brows.

"Our goal...? Shouldn't we just defeat the Legion, and that's it...?"

"No. The enemy's objective is occupying the Revich Citadel Base, and it's for this reason that they're shutting out the surroundings and sending in reinforcements. In which case, our objective should be to prevent that... In other words, retaking the citadel."

Theo spoke, and the sensation of him tilting his head quizzically transmitted through the Resonance.

"So...you're telling us to attack the base, Lena?"

"Precisely, Second Lieutenant Rikka... But in this situation, there's only one basic siege strategy we can adopt."

Fundamentally speaking, in siege battles, the side holding the castle had the advantage. Fortresses were military installations

built and designed to prevent an enemy's infiltration. They were meticulously constructed on specific battlefields that would put the side being sieged at an advantage. Castle walls were one such example, as they deflected enemy arrows while being equipped with many devices and schemes to allow the side holding the fort to rain concentrated fire on the enemy.

This meant the side performing the siege had to adopt tactics that ignored the walls. Like schemes that drove the occupying force to come out. Or starvation tactics, though those often put the side holding the siege at a disadvantage if the other side had stores of goods hauled inside. Other tactics included destruction of the walls, digging of tunnels to burn down the ramparts, and using battering rams and counterweight-type trebuchets to crush the walls.

But none of these tactics were viable in this battle, and the Legion were immune to all negotiation and intimidation. They would ignore any provocation and would never succumb to war weariness. Since neither side had a line of supply to support it, relying on attrition would be a double-edged sword, and they lacked the time to do so, anyway. Finally, burrowing their way into a base protected by granite, and placed on top of a cliff at that, was impossible.

And with all that in mind, only one method remained. Picking up on what Lena was about to say, Shin answered with a slightly stiff voice:

"...We have to charge the fort."

Forcing their way through the ramparts. Flocking their way up the walls like ants charging a source of food. The easiest, most utilized...most unskillful tactic, which would claim the greatest number of lives.

"Yes... I'm going to have you scale a one-hundred-meter cliff as well as twenty-meter-tall walls."

A heavy silence fell over the improvised conference room for a moment. Be it the Republic models or the Federacy ones, the Eighty-Six's Juggernauts were meant for battle in urban or forested areas. They were used to vertical movements using wire

anchors. But...an ascent of over one hundred meters. Even a Juggernaut wouldn't be able to climb that distance in a single bound, especially when exposed to enemy fire and self-propelled mines attacking them on the way up.

"That'll be..."

"Hard. We'll take considerable losses."

An ashen-faced Rito moaned, and Yuuto agreed with a severe expression. Raiden then said calmly from beyond the Resonance:

"How about you forget the base and retreat?"

"Out of the question. Even if we retreat, we don't have the supplies to regroup with the main force."

Shin cut off his proposal. That exchange of question and answer was meant to inform the Processors of the situation. The Eighty-Six fought in an unusual environment for soldiers, and the concept of lines of communication and supply was unfamiliar to them. They didn't have any experience marching through battle for days. Nothing good would come of having them fight without understanding why they needed to retake the citadel base.

Shin ignored the intent hidden behind that question. On the off chance they might abandon the base. But they wouldn't ever do that, no matter what.

"We'll make retaking the base our priority and buy time against the heavily armored Legion units with stall tactics. About right, Colonel?"

Stall tactics. A strategy that involved impeding the enemy's advance while avoiding direct conflict and slowing their movement. Since it was based on repeating hit-and-run attacks, it required a good deal of distance between the enemy and the target they would be defending, but based on the enemy reinforcements' current position, they should be able to buy a few days.

"Yes."

"Master Sergeant, I'm putting half our Juggernauts and the artillery battalion under your command. Handle the enemy reinforcements, all right?"

"Yeah, I figured that was how it'd go."

Bernholdt nodded indifferently. The Eighty-Six were technically officers and were placed under the command of a

noncommissioned officer. This was a situation that wouldn't be possible in a normal military, but the Eighty-Six only ever saw ranks as decoration to begin with, and so did the mercenaries. The gathered squad captains gave no objections, either.

"Five days. Aim to buy time until reinforcements arrive and nothing else. Don't even think of trying to take them out."

"That goes without saying, chief... You guys don't rush in all gung ho like idiots and get yourselves killed, either. Otherwise, we'd feel like dumbasses for protecting you."

Perhaps it was because of the nature of the situation they were in that Bernholdt allowed himself to say that. Shin shrugged at the veteran noncommissioned officer, who'd cracked a joke that bordered on the disrespectful, and moved his gaze to the other squad captains.

"The remaining Juggernauts and Alkonosts will all participate in retaking the base... Our side can't let this last five days. We have to recapture that base before the people in the command ward get wiped out."

With the operation's details decided, both Lena's group inside the citadel and the Strike Package outside set to work. Taking nighttime shifts into account, the base's command personnel mixed in with Vanadis's control crew. The Handlers Resonated with their Sirins in the control room, and any surviving soldiers set out to secure the corridors. Raiden's group was on standby in the hangar, which stood as the largest and most probable invasion route.

Grethe Resonated from the capital, informing them that preparations had been made to send in the reserve forces.

"The Legion have started closing in from all over on the second southern front, which is where you all are. His Majesty and the crown prince have decided that this isn't a situation where they can afford to be stingy with the reserves."

"Thank you, Colonel Wenzel."

"...We appreciate the message, but...I'll make sure to scold Father and Brother Zafar and tell them off about using military officers from another country as their lackies just because they're

busy, Colonel.”

Outside, the Juggernauts had begun moving out, be it to intercept the heavily armored units or to surround the base. With the climbing irons attached to their feet adding a distinctive sound to their footsteps as his backdrop, Shin said:

“Colonel Milizé. Vika. Can I leave command of the full force to you? I only know a few strategies when it comes to siege battles. It’s probably beyond me, to be honest.”

“...Yes, you were a special officer academy child, come to think of it. A quickly promoted officer wouldn’t know.”

As Vika spoke, he left the command ward’s ammunition depot, checking the operation of a spear-like heavy firearm with practiced movements. The thought occurred to Lena that the Idinarohk royalty truly were a militaristic bloodline. It was a 20 mm anti-tank rifled cannon, one of the older anti-tank weapons for infantry use, equipped with large amounts of propellant and a long barrel to grant its warheads the supersonic speed needed to penetrate armor. It was discarded due to the strengthening of tank armor and the introduction of lighter and/or more powerful recoilless rifles.

But unlike said recoilless rifles, which couldn’t be used in confined spaces unable to accommodate the several-dozen-meter-long flames they ejected, it didn’t disperse anything but a loud bang. This weapon was still usable here in the command ward, with its many cramped corridors.

After finishing his inspection, Vika handed two of these fifteen-kilogram rifles over to one of the royal guards and continued speaking as he saw him carry them off from the command post to set them up in the corridors.

“True, I may have studied on a bit more of a systematic level, but I don’t have any experience in siege battles, either. Though I have more experience than I wish I did when it comes to nesting up.”

“If you’ve studied it on any systematic level, you’d still know more than me. I have experience with holding down positions, but I can’t imagine being on the other side.”

“Yes, I suppose.”

“...But—”

Lena noticed something and parted her lips to speak. If even Shin, who had the most experience out of all the Eighty-Six, didn't know much about this topic, that would mean...

"If that's the case, wouldn't that mean...that the Legion don't know how to fight within this fortress?"

A violet right eye turned in her direction.

"Including the ones inside the citadel, most of the Legion are presumed to be Sheepdogs, though."

"Yes. Intelligent soldier types made by assimilating the neural networks of Republic citizens."

Republic citizens who couldn't fight back and ended up being taken by the Legion, thus involuntarily bolstering their ranks.

"But that would mean civilians without any combat experience were made into soldiers. Their intelligence may be equal to the average human's, but if that's the case, they shouldn't be able to properly perform anything they don't know."

The Republic citizens had sequestered themselves within a false peace, treating the war raging outside the walls like a movie at the cinema. Even most of the Republic's soldiers had never so much as fired a gun. And the majority of the Shepherds who led them were likely Eighty-Six, as well.

The Republic was the only nation that left corpses unattended, allowing them to be collected in the Legion's Headhunts. The Federacy, the United Kingdom, and the Alliance had all taken considerable measures when they realized the Legion were taking in their war dead.

To begin with, those countries poured all their strength and energy into valiantly resisting the Legion, even outside of battle, and took the bodies and those injured back at all costs. It was easy to imagine, then, that the Eighty-Six, who never received aid and were lacking in manpower, and had been forbidden from collecting their corpses at that, were the key ingredient that went into producing Black Sheep and Shepherds.

And these Eighty-Six were child soldiers who had never received elementary education, to say nothing of a soldier's training. Rich as their experience in the field may be, they wouldn't have any knowledge of laying siege. And the same held true for the Legion in their natural state, which were only soldiers

obeying the Empire's orders. They may have gathered and analyzed eleven years' worth of combat experience, but they wouldn't be able to analyze a form of combat they'd never experienced.

And siege battle was a military tactic that hadn't been employed in over a century, with the growth of long-range artillery and the introduction of airborne weapons. It would only be registered as knowledge of something that had once existed.

"...I see. So in terms of knowledge, we still have the upper hand."

His eyes narrowed in the darkness, and he broke into a ghoulish smile. A despotic tyrant's pleased grin.

"It may be a golden chance to teach these peaceful, common citizens the inherent vileness commanders can have. In which case, leave the nasty job of commanding the defense of the command ward to me... Milizé, you take command of the siege outside. I'll transfer total command privileges over the Sirins to you."

"Right. Captain Nouzen, you heard him."

"Roger... Thank you very much."

Grethe then said, **"We can handle simulations and investigations on this side, so send any query you need our way... And also..."** She seemed to hesitate before speaking again:

"A message from His Majesty... There's no need to rescue Prince Viktor. Should you have to abandon him, he won't hold the Federacy or the Strike Package accountable..."

Lena was momentarily shocked. Impossible. His Majesty—that is, the king—was Vika's father. Vika, on the other hand, shrugged as if this was obvious.

"Makes sense he would say that. I'm a soldier, and this is the United Kingdom's battlefield. If he would hold you responsible, he'd be a laughingstock for ages to come."

"I think this is kinda strange," Annette said as Grethe turned off the Para-RAID. They were in a room in Roa Gracia's royal castle. It was so extravagant and comfortable it made them feel guilty being there while Lena and the others were in the middle of a

crisis.

"Their objective aside, they managed to pinpoint and attack the Strike Package again," Annette continued. "It feels like they're reading our movements a little too well."

Grethe nodded. The Revich Citadel Base was a United Kingdom forward observation point that overlooked the lowlands. It had no value that would justify the Legion attacking it. In which case, their objective here was the Strike Package, but that was weird in and of itself.

"What are the odds of the Para-RAID being intercepted?" Grethe asked Annette quietly.

"Slim to none... I can't say it's impossible for the Legion to Resonate, given that the Sirins, who are also made with copies of human neural networks, can. But you need to have your settings aligned to Resonate with a particular target."

"Maybe the Legion can trace the captain's location, same as how he can hear their voices?"

"That's unknown at the moment... But there's a simpler explanation."

"Yes."

Grethe heaved a single sigh heavy with depression and a soldier's coldheartedness.

"We can't rule out the option...that someone's been leaking information from within the Federacy military."

Lena entered the room that had been allotted to her as living quarters and, after undoing her blouse and stockings, looked down at the thing in her hands. The Cicada. The Thought-Support Device Vika had given to her to lighten the strain of Resonating with over one hundred people. She hadn't used it during the recon mission. It was too short, and her only Resonance targets were the several captains.

But this time, she couldn't afford not to use it. She needed to have the entire brigade out there under her command, which made the number of Resonance targets that much larger. With the siege battle predicted to be particularly savage, if she were to pass out, there would be no one to command the Strike Package

outside. And while he might be willing to take her place, it would put considerable strain on Vika, too.

Lena braced herself with an “okay” and drew up her long hair, placing the Cicada on her neck so that it came in contact with her RAID Device. She felt the cold of the quasi-nerve crystal against her body heat and the bioelectric current running through her skin.

The Cicada—the Thought-Control Device—came to life.

The silver threads that made up the ring of the device unfurled, going from a solid, unified state into what seemed like luminescent snow. Countless strings, like a silkworm moth’s strands or a spider’s thread, became a torrent of light and trailed down Lena’s white back. The silver threads lit up with faint-violet light. They propagated with explosive speed, like a tangle of rapidly spreading vines, crawling and coiling over her shoulders, back, and arms.

“Ngh...”

She felt a peculiar, almost ticklish sensation of touch over her skin. As if she were being caressed with the tip of a feather, as if her skin were being lightly traced by a person’s finger.

“Unf... Ah...!”

And as the threads continued their self-propagation, they crawled all over her, enveloping her entirely from the neck down before stopping. The end result was an outfit that covered up her whole body, like a tight bodysuit of sorts. The silver threads were made of quasi-nerve fibers with a self-propagating feature, their surface having an intertwined, almost organic sort of appearance. The device employed the wearer’s bioelectric currents as its power source, forming a quasi-nerve network that covered the body by way of the fibers—a supplementary, full-body brain.

Perhaps it was part of the boon of its supportive powers, but when she opened her eyes, her field of vision felt slightly clearer than before. Taking a single breath, Lena raised her head in the dimly lit room.

With the added thickness of the device wrapped around her like an outfit, Lena wasn’t able to comfortably get her arms through

her uniform's sleeves, and it felt tight around her shoulders, so she put on only her pumps and returned to the command post. The deployment of the device was thinner around her legs, which were farther from its point of origin, so they were about as thick as her stockings, allowing her legs to fit into the shoes without issue.

Hearing the clicking of her heels, Vika turned his gaze in her direction. Frederica, being a child, relinquished her seat and stood by the vice commander's. They both looked at her with a peculiar expression and fell silent for a moment.

"Yeah... Hmm..... I'm sorry. This is all my fault."

".....!"

Hearing the prince act politely only now, after apologizing this late in the game, made Lena glare at him. Uncharacteristically, Vika was desperately looking away from her in a cold sweat.

"To be honest, I have Lerche use it, too, when necessary... But hmm, yes, indeed. I realize now it was only fine by virtue of her being a lot more...*modest* than you are..."

"What's that supposed to mean?!"

"You're...very well-endowed."

"Endowed with *what*?!"

Even Frederica looked at them with pity and a complicated expression.

"It seems even this imbecile is at a loss due to how...er... *tempting* this appearance is to the eyes of a man."

She tried to pick her words carefully, which only served to make Lena more shocked. It felt as if she'd just been told to her face that she was walking around indecently.

The Thought-Support Device—the Cicada. A bodysuit-type computation unit made up of quasi-nerve fibers.

However, since it operated by using the wearer's bioelectric current as its power source, and since the quasi-nerve fibers had no means of maintaining their posture, they had to deploy over the skin. Which meant aside from adhering to a form, the material also had to support itself against her body tissues.



In other words, it tended to sway a lot. Especially around the chest.

The command personnel all looked away in a reserved if blatant manner, with her gaze falling on one young man in particular who had his eyes desperately glued to the screen in front of him.

"...Second Lieutenant Marcel, why are you refusing to look at me...?!"

And still, despite his colonel's inquiry, Marcel didn't move his eyes away from the monitor.

"Colonel, could you please not sentence me to death, even indirectly? If I turn around now, Nouzen will murder me for sure."

"Wh-why are you bringing up Shin...?!"

Hearing that name only made her more embarrassed, which prompted Lena to blush profusely.

"Well... Y'know. Anyway, we'll try to get you a bigger uniform for the next operation, Your Majesty."

Shiden said this over the Resonance, her voice unable to suppress her sympathy. Frederica left wordlessly, only to come back with a thick steel-blue Federacy men's blazer, which she draped over Lena's shoulders.

Lena had disconnected for a while to make preparations to control the Spearhead squadron's deployment and had finally reconnected to the Resonance.

"All Strike Package members. I apologize for the wait."

"It's fine... Colonel?"

Shin noticed something was off and asked about it. She'd cut off the call over ten minutes ago.

"Did something happen?"

"Like what?"

He knew it.

"Your voice... You sound upset."

Her silver-bell-like voice was thorny to the point that it was impossible to hide it. And her tone sounded unusually curt.

"It's nothing."

So something happened. He'd ask someone after the battle.

Probably Frederica or Marcel. He didn't know what it was, but he figured asking Lena herself would be a bad idea.

Lerche then reported, with an oddly apologetic tone to her voice:

"...Sir Reaper. We, er, finished deploying the Alkonosts, so..."

"...? Roger. Colonel, the Strike Package is deployed and ready to go."

"Good work. Remain on standby until further orders."

Heaving a sigh, Lena seemed to have pulled herself together. That usually refined silver bell of a voice still had a hint of agitation to it. Something about it felt fidgety and embarrassed this time. The emotions being transmitted felt fairly strong, which made Shin furrow his brow. Speaking through the Resonance conveyed emotions at the same level as conversing face-to-face would, and at that moment, they came across extremely vividly.

"Is something—?"

"Captain Nouzen! Remain. On. Standby!"

"...Yes, ma'am."

It was past noon, and while it wasn't quite sunset yet, snow began to flit down from the darkened sky. The heavy, lead-colored clouds dyed over by silver dust soundlessly scattered flakes of white toward the earth.

The Revich Citadel lay beyond the horizon, lording over all like the crouching carcass of a giant. The cliff had a difference in elevation that was three thousand meters at worst and a thousand meters at best. With the incessant snowfall, this cliff was now clad in a thick cloak of frost, with steel plates covering the peak.

In terms of topography, the citadel area was the highest one, while the part facing the southern contested zones—in other words, the conifer forest Shin and his group were currently in—was more of a gentle descent.

The forest had likely been cut through to help intercept attacks from above, and the area that spread over a diameter of several kilometers around the base was plains that were unnaturally devoid of surfaces that could serve as cover. The Strike Package marked a rocky, diamond-shaped mountain that extended to the north and south as their point of attack due to its low elevation

difference and relatively close distance to the forest.

"...If we go out there carelessly, we'll be sitting ducks," said Anju.

"Still, there's nowhere else we could go out from... If it weren't that kind of castle, we could at least pump them full of artillery shells."

Being surrounded by walls on all sides also meant there was nowhere to run, which made it a prime target for surface suppression, which involved scattering high-explosive projectiles over a large set area. But the fortress had a thick rock canopy formed by the glaciers' erosion of the mountain that served as its natural defense. It was now reinforced with metal pillars and served as a solid defense against bombardment and bombing. In that regard, perhaps an attack from the Morpho or a bomber plane carrying heavyweight, supersonic cannons might be capable of penetrating it, but mediocre bombardment wouldn't.

Theo cracked that joke knowing all of that, but their comrades were still trapped inside. And sure enough, Kurena knit her brows.

"Isn't Raiden in there...? And, well, I'm worried about Lena, too."

"I was being hypothetical. That's why Shin handed all the Juggernauts that used artillery weapons over to Bernholdt's side."

The Reginleif's primary and side armaments were exchangeable, and the Strike Package had two battalions of howitzer-equipped artillery-use models. Those were both sent over to aid in the stalling operations. Like Theo said, they weren't suitable for this sort of combat and were better off offering suppressing fire in the battlefield swarming with heavyweight Legion.

There were no signs of the enemy around the base and no trace of the ghosts' whispers save for the Sirins. As he listened to the screams of agony that came only from within the base, and namely from the surface sector, Shin asked, "Anju, any way you could fire those rockets through the gap between the canopy and the walls?"

"Shin, what?!"

"Hmm..."

While Kurena panicked, Anju simply replied quizzically.

"I could assign the missile's targets but not direct their trajectory. And the base's core facilities are all underground, right? Even assuming I could do

something about the Legion on the surface level, I can't reach the ones in the underground sectors."

"I figured that if we can suppress the surface even for a short while, it might buy us time to get in... But I suppose that's out."

"Guess there's no way in but to climb up, after all..."

Dustin, who'd been listening silently, then said:

"...Out of curiosity, why can't we climb up the northwestern entrance gate? No one even mentioned it in the strategy meeting, so I understand that it's not a good idea, but there's an actual path into the base there. Isn't it a lot safer and faster than scaling up the walls with wire anchors?"

Shin blinked for a moment. It was common sense for an Eighty-Six, and he didn't expect to be asked about that.

"Because the enemy will be waiting for us at the entrance... And that path in particular is built to allow the defensive side to rain concentrated fire on the attackers climbing up."

"...Concentrated fire? Ah...!"

It dawned on him. The northwestern entrance into the Revich Citadel Base was built on a needlessly convoluted hill full of sharp hairpin curves. If they were to attempt to climb it, they'd be met with obstacles at the side of the road and the walls on both sides of the fan-shaped gate. Advancing along the road meant you wouldn't run into any obstacles, but it also meant you would be exposed to concentrated fire from three directions for a prolonged period of time. Not only would they never reach the gate, but the losses they would take would be absurd with nothing to show for it, and the way back would be riddled with the wreckage of fallen units.

"But the fort's interior doesn't have that kind of cannon, and you don't have to go along the road itself..."

"We haven't confirmed it doesn't have it, and if we go off-road, it'll be full of obstacles, not to mention that if you get far enough away from the pavement, the place will probably be riddled with mines. And using bombardment to clear away mines isn't the safest method."

Mines had a habit of going off before they were removed, and they were intentionally designed to target an enemy's weak points. Truly a nasty weapon. Vika, who had apparently been

listening in, then said with the spiteful smile of an ornery tiger:

"Correct, Nouzen. As vicious as you think me to be...I agree. It doesn't just apply to this castle, but you'd do well to avoid attacking it head-on recklessly. Exits and paved roads aren't necessarily places man can traverse."

Places that were the most efficient spots to set traps in—and places the enemy would be paying the most attention to.

"You should be careful even after you get in. The Legion mowed a few of them down, but there's still a few defensive mechanisms active."

"...Did you seriously just say you planted mines inside your own castle...?"

"It's better if I planted them knowingly, no...? If you think you're safe from mines or traps just because you're in your country's territory, you may end up learning quite painfully how mistaken you are."

"..."

Sagittarius's optical sensor turned to the ground in a visibly uncomfortable gesture.

"So there's no way in but to scale the cliff, like it or not... But first, there's a need for reconnaissance. Who wants to lead the charge?"

After a long silence, Vika chimed in.

"Don't tell me you don't understand yet... Care to enlighten them, Lerche?"

Lerche, who had maintained a reserved silence until now, replied with a hint of pride:

"Have you forgotten, friends? We Sirins are the wings created for that very purpose."

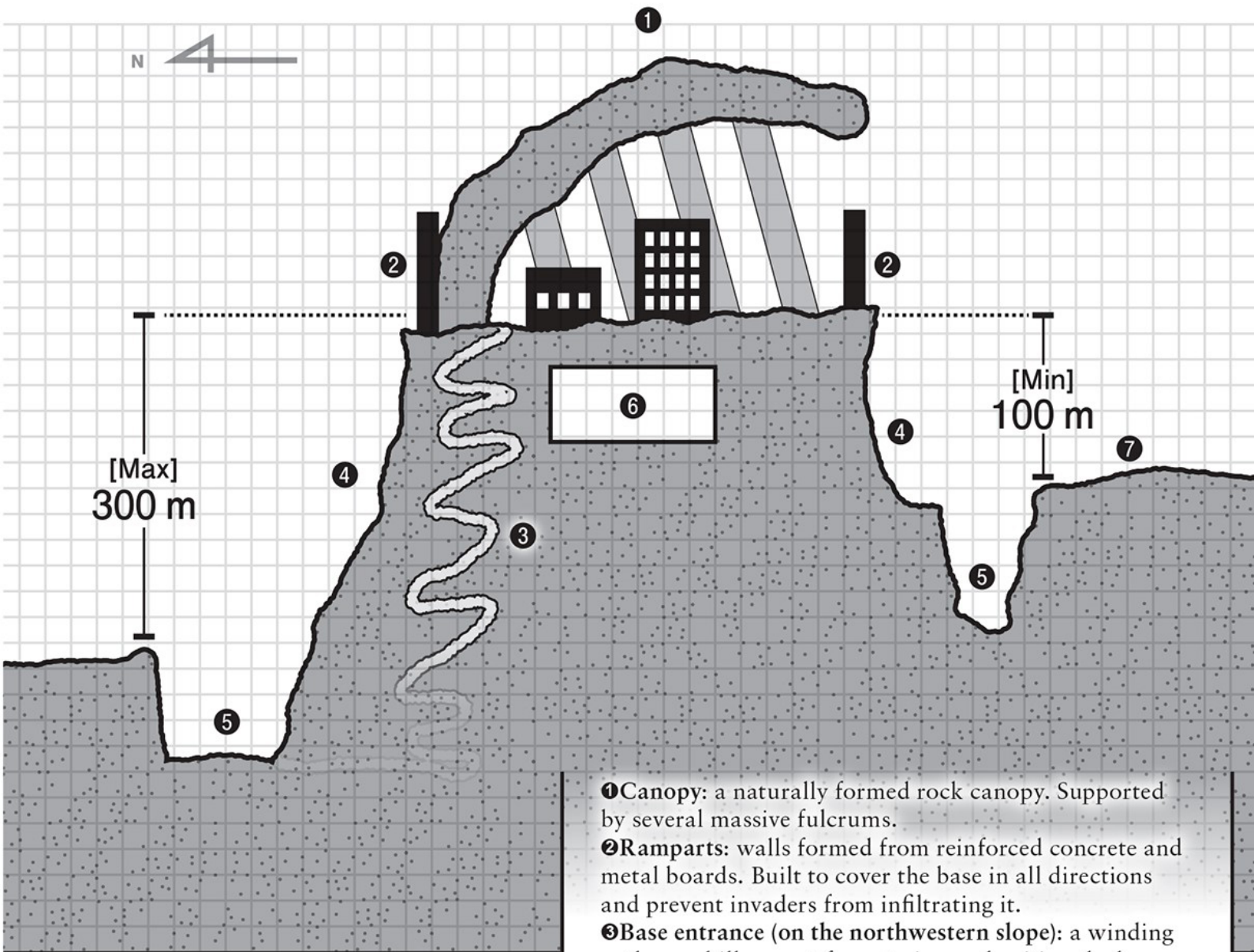

Operation Outline

The United Kingdom's observation base, the Revich Citadel, has been occupied due to a Legion aerial raid. As a result, the advance party, led by Captain Shinei Nouzen, and the delayed party, led by Colonel Milizé, have been split up. In addition, there are reports of Legion reinforcements closing in. The advance party is to swiftly retake the base and regroup with the stranded delayed party.

- ① **Canopy:** a naturally formed rock canopy. Supported by several massive fulcrums.
- ② **Ramparts:** walls formed from reinforced concrete and metal boards. Built to cover the base in all directions and prevent invaders from infiltrating it.
- ③ **Base entrance (on the northwestern slope):** a winding path up a hill, meant for entering and exiting the base. The travel distance is long, and there are no means to prevent attack from uphill, making it a difficult climb for invaders.
- ④ **Frozen cliff face:** an inverted wall carved from stone and ice. At its highest point, it is three hundred meters tall—at its lowest, a hundred meters.
- ⑤ **Dry moat:** a twenty-meter-deep moat. Has no water running through it. Its bottom is filled with metallic anti-tank obstacles.
- ⑥ **Base command post:** the underground command post where Colonel Milizé and First Lieutenant Shuga are isolated. With the exception of the command post and the adjacent eighth hangar, all other sectors—the surface included—are under Legion control.
- ⑦ **Current position of Captain Nouzen and his forces (southwestern area):** They have set up camp in the southwestern area, where the walls are lowest, and are near a forest that shelters them from enemy fire. The traversal is estimated to be extremely difficult, however.

※ Note: Points ②, ④, and ⑥ completely encircle the base. The diagram is unable to fully reflect this, as it is illustrated from a side view.

* * *

One team of four Alkonosts rushed out of the forest. They detoured around so as to create distance between themselves and the siege team but moved in a straight line away from the camp. Remaining vigilant of enemy bombardment, they kept a distance of a hundred meters from each other as they moved in a wedge formation and continued on, the strange noise of mechanical claws cleaving into ice accompanying their footsteps.

"...Sir Reaper. Since the data link has just arrived, I've taken the liberty of relaying it to you."

Following Lerche's report, a holo-window popped up in Undertaker's cockpit. It showed footage of the recon units' gun cameras, using Chaika as a relay. They were several hundred meters away from the citadel, and the precipitous cliff seemed to stretch high into the heavens from their vantage point.

The proximity to the base just made its impregnability all that more noticeable. A wall of ice stood one hundred meters tall, and on top of that, there was another wall of thick, reinforced concrete covered in armor plates. And worse still, the cliff had been intentionally crumbled so as to draw a light arc, making it impossible to climb over. Even using wire anchors, one wouldn't be able to climb to the top in a single bound.

But before even that, there was a ten-meter-wide, twenty-meter-deep dry moat surrounding the ledge from all directions, without exception. The Reginleifs and Alkonosts were light by Feldreiß standards and could jump across that distance, but there was a solid wall of thick ice beyond it. If they were to fumble firing off their wire anchors, they'd fall to the bottom of the moat, which had sharpened metal thorns packed closely together, meant as anti-tank obstacles.

"...Yeah, but if we shoot anchors directly below the wall and pull them taut, we should be able to climb," Theo said, viewing the same footage.

"But we'll probably bring the whole thing down if we fire too many of them, so only a few of us will be able to climb. We can blow away the anti-tank obstacles and slip through that way. If we can just open the gate, the rest should be able to get in normally..."

The sentence trailed off. Shin's ability picked up the movements of a Legion. Looking up at the walls, they saw a massive steel-colored shadow peeking out of the arrow slits, which were in the shape of a saw's teeth. A menacing silhouette characteristic of a weapon, and the elongated shadow of the cannon barrel set upon its back.

Lerche said, **"Lady Queen, Sir Reaper... We will be firing at this cannon shortly. We need to confirm its attack method and effective range."**

"Take every precaution to avoid a direct hit. We can't restock ourselves here, so we need to avoid as many losses as possible."

"By your will..."

The steel-colored shadow leaned forward, taking aim at the Alkonosts directly below the walls. The system traced their field of vision automatically and zoomed in. The distant image of the unit became clear. It was roughly the same size as a Stier and had the reddish-black frame characteristic of the Legion. But it was noticeably unarmored. Its large cannon was thrust upward atop its four-legged fuselage, its mechanisms exposed. From its rear extended a pair of elongated plow-like parts reminiscent of a scorpion's tail.

The ghost's roar rumbling in Shin's ears made it clear this was a Legion. But in seven years of fighting the Legion, Shin had never seen this kind of unit before.

No... True enough, as a Legion he'd never seen it, but he'd seen this detailed form before. A long barrel with massive, imposing mechanisms. The barrel had a sinister muzzle and rear spades for absorbing the recoil during artillery fire. He'd never seen anything like it in the Eighty-Sixth Sector, where they received no support, but he had seen something like it in the Federacy, where providing rear support was a given.

It was larger than a tank's barrel or any sort of rifle. The god of the battlefield, which despite being absent of any desire to kill or will for slaughter, unknowingly claimed the largest number of lives...

A howitzer!

"Lerche, have the Alkonosts pull back! That's a—"

It finally dawned on Shin why the Legion had gone to the trouble of adding heavy, buffered containers into the units they'd

launched. After accelerating, they lacked the mobility to land on their own...because their design was never intended for them to be present on the front lines.

"It's a Skorpion!"

A rumbling roar.

The Legion's largest cannon—a 155 mm howitzer—fired a volley at the Alkonosts standing near the moat.

"A Skorpion?! Are you saying they brought one of their artillery types from the rear to the front lines?!"

It was only natural that Lena was shocked enough to respond with a question of her own. The Skorpion types—and howitzers in general—packed unrivaled firepower but at the same time were relatively helpless on the front lines. So to think the Legion would send them in—and while assaulting a fortress, at that...

"Why would they...?"

Vika clicked his tongue loudly.

"...So that's their play. Milizé, don't have the Alkonosts pull back. The Skorpion types were brought in to destroy the command ward's partitions."

Lena gasped. A 155 mm high-explosive projectile packed enough firepower to blow a tank to smithereens if it hit directly. And the command ward's sturdy bulkhead partitions would eventually crumble if exposed to concentrated fire.

They packed the highest firepower possible against fixed targets and were at the same time lightweight units capable of being launched by a Zentaur—which was likely why they'd been chosen. Based on the types that it had been observed to catapult, the maximum weight that it could launch was ten tons.

The Löwe weighed fifty tons, and the Dinosauria weighed at least a hundred tons—their barrels alone were over the permissible weight. In contrast, the Skorpion had a simple form. Its weight was mostly in its shell, and its only real attachments were its legs, so it was one of the lighter Legion units. The fact that it was unarmored made it extremely convenient in terms of the weight limit.

They'd sent it in because it fit the requirements. There was no

trace of the human logic of keeping their artillery in the back, where it would be safe. The Legion didn't shy away from the prospect of rushing into a minefield to clear it and, despite being on the same battlefield as humankind, which shirked from sacrificing comrades, acted on a different sort of logic altogether. Which had led them to this course of action.

It was the same.

"...Having the Sirins recklessly approach the Skorpion types, with their area-suppression abilities, is..."

"If they didn't care about protecting the walls, the Skorpion types would fire at us instead. In which case, we need the people outside to draw the Legion's attention, at least to some extent."

"..."

It was the same as how Lena, who commanded people, and Vika, who commanded machines, acted on different forms of logic.

But when it came to the battlefield, Vika was in the right. Naively hesitating when faced with the death of the few in front of her would result only in *everyone* under her command dying. So hardening her heart, Lena gave the order, praying with all her might that her self-loathing and terror wouldn't be transmitted to Shin and the others over the Resonance.

"All Handlers. Proceed and advance the second squadron. Try to evade as much as possible going forward and keep the enemy's cannons pinned to the top of the walls. Don't give them a moment's leisure."

"...Roger that. The Juggernauts will attempt to close the distance, too," replied Shin, directing a bitter gaze at the decimated ruins of the Alkonosts annihilated by a barrage of 155 mm shells capable of sweeping through a radius of thirty meters. There was no way he didn't understand the meaning behind Lena's pained order. The Skorpion types were far from an ideal pick for defending the walls. Their forty-kilometer range was too long in this scenario, with a large gap between their azimuth and inclination sights; they were never designed to be present on the front lines, after all, and so they weren't suited to it.

THE BASIC DRONES

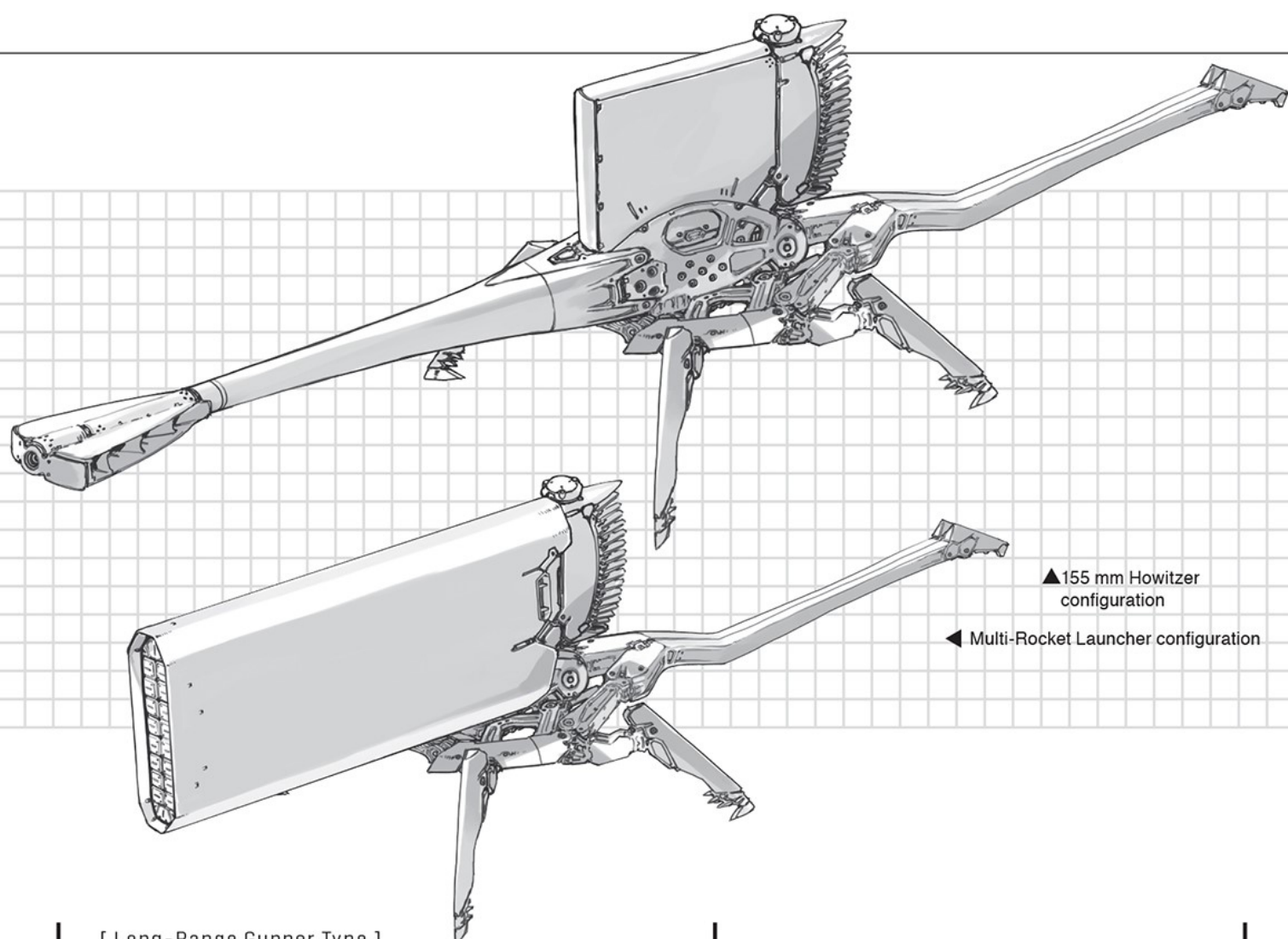

[Long-Range Gunner Type]

Skorpion

[ARMAMENTS]

155 mm Howitzer or Multi-Rocket Launcher

[SPECS]

Total Length: 11.0 m / Height: 2.2 m

※Fundamentally, this is a unit meant for providing covering fire by shooting high-angle fire from far behind the front lines, but it is also capable of horizontal fire.

An artillery-support unit that first appeared in Volume 1. It keeps its distance from the front lines and shoots from outside the enemy's range. True to that concept, it's almost entirely unarmored and has very low mobility. In addition, since in essence it's made up of only its barrel and its stability legs, it is lightweight despite its size (much like how most of a tank's weight stems from its armor).

As mentioned in the story, this light weight enabled them to be launched into the citadel via the Zentaurs. This unusual application, which is incredibly different from their normal use, may be the influence of the Legion's overall increase in intelligence.

If they didn't keep them occupied, the Skorpion types would turn their sights to Lena and the others inside. Shin turned his consciousness to the captain of the platoon he'd sent to the walls as reinforcements. A unit meant to eliminate the Legion on the walls. To make the enemy cover their heads and fall back, enabling the unit to close in on the walls.

"...Kurena. Are there any points you could snipe toward the walls from?"

That question made Kurena bite her lip. She inspected the map and found one of the sniping points she'd noted. A slightly elevated ledge in the snowy forest.

"A few. But..."

She'd honed her sniping skills out of her wish to help Shin, who faced the enemy head-on as a vanguard. Her role was to remove enemies that got in their way at times like now. He would surely need her help here. So long as she could do this, she would get to stay at his side on the battlefield. It was her role and hers alone; she would relinquish it to no one, and not even Lena would be able to overtake her when it came to this.

And yet, she had to make this report. She moaned despondently at the sight of the sensors of brand-new buckshot mines flickering repeatedly on the ledge, covered by the light snow. They'd likely been set there to catch them off guard as they returned from the Dragon Fang Mountain conquest operation.

"It's riddled with mines...! They set anti-tank mines all over the place!"

The thundering sound of an explosion enveloping the ledge reached even this far. Raiden looked in the direction of it and spoke, as his Juggernaut's sensors couldn't pick up anything beyond the concrete-and-rock wall. "So the defensive line in the passageway got to work, eh...? Sounds like the guys are struggling out there."

"Well, yeah, you try rock climbing up that crazy cliff. Even Li'l Reaper's gonna have trouble with that."

They were in the eighth hangar, on the lowest level of the Revich Citadel Base. It was the largest hangar in the base, a huge space that took up that whole level, with a breadth and length of over five hundred meters. It was tall enough to contain a civilian house, and aside from the lighting, gantry cranes filled the ceiling, surrounded by catwalks. The Juggernauts formed a barricade out of empty containers and hid in its shadow with Wehrwolf in the lead.

Looking through his optical sensor, he eyed the entrance that led to the elevator, which currently had its anti-fire shutter lowered, the violent sound of explosions roaring from behind it. It was the sound of the Legion from the lower levels launching repeated suicide attacks. The self-propelled mines' self-destructing and the Ameise's bashing gradually started breaking through the shutter. It had started to warp and creak. With a single powerful *thud*, the shutter's surface crumpled and tore open, giving them a glance at the group of metallic monstrosities writhing outside.

...They're coming.

"—All units, remove safeties. Stay put until further orders..."

Another blast. The shutter was incapable of taking any more damage and was blown off spectacularly. A stream of self-propelled mines intermingled with Ameise poured into the hangar, and as their shining optical sensors swerved to and fro, searching the darkness for their prey, Raiden gave the order.

"Fire!"

In the next moment, a horizontal line of fire swept down onto the Legion from their flank. The low growl of an autocannon and the screeching of two heavy machine guns filled the hangar, sending the severed legs of the Ameise and the dismantled limbs of the self-propelled flying units into the air in puffs of black smoke and bursts of flame.

However, the second wave was all too eager to trample over the bodies of their downed comrades to enter the hangar, heedless of the hail of bullets. They closed the distance in the few seconds the fire stopped in order to prevent the barrels from overheating, descending on the Processors as they silently stepped over their comrades' remains.

"Ha, rushin' in like ants... Don't let a single one pass! There's nowhere for

us to retreat to, ya hear?!”

Shiden barked at the Brísingamen squadron, who replied in turn. It soon became a chaotic battle, with mobile weapons moving about and aiming at one another's weak spots as self-propelled mines tried to rush in between them. Not just the Juggernaut but all land weapons tended to be less armored on their surfaces, and in an attempt to capitalize on that weakness, some self-propelled mines climbed up the walls to reach the catwalks—

“Here they come! Knock ‘em down!”

Busting through the glass of the standby room overlooking the hangar, an assault rifle's fire, set to full-auto, rushed them. Setting out to clean up those that got away, the Eighty-Six maintenance crew shot concentrated fire at the self-propelled mines.

They'd been forced to leave the front lines due to injuries and the resulting damage to their bodies, but they were originally combatants accustomed to handling firearms...as well as the air of the battlefield and the sensation of brushing against death. The Ameise turned their sights onto them at once.

“Retreat—fall back!”

A moment after that shout and their loud footsteps, 14 mm machine-gun fire swept through the standby room. The following moment, though, Shana's unit, Melusine, trampled over the Ameise. Shiden looked around the hangar and spat out, **“Doesn't look like that Phönix thing showed up here...”**

“Not that I'd want it to show up right now...”

There were no records of battle with the Phönix in any corridors since it took over the observation tower. The bulkhead partitions in the underground sector were set up with high-voltage traps as a measure against high-frequency-blade attacks, and the last sighting of it was of its blade being deflected off one of those. According to Shin's recon, it was definitely still somewhere in the base, but it was either damaged or under repair. Or...

“...It's the Legion's trump card.”

They'd left suppression of the base to the low-rank grunts... and kept it hidden for a battle where it would be needed most.

“It's powerful but irreplaceable. They probably don't want to use it on scrubs like us.”

It could tear through anything and shoot through anyone, and for that reason precisely, it was one of a kind. Which meant it would join the fray only when an equally unique unit—Shin and Undertaker—would appear to serve as its worthy opponent.

Shiden scoffed ferociously.

“Scrubs, huh? I’m starting to really want to pull that complacency out of them, along with the rest of their guts.”

“Cut it out... We’re in no situation to be pickin’ fights with them when we’re this short on heads.”

“—Corridor five, fall back to corridor three. Mow them down. Thirty seconds later, go back in to retake. There are Ameise equipped with heavy machine guns coming from corridor zero. Rifle unit, retreat and provide covering fire with anti-tank rifles. The moment they show their faces, take them out.”

As he commanded the action taking place across multiple corridors, Vika’s rapid succession of orders echoing through the command ward made it clear just how severe the fighting on the defensive line was. All the corridors leading to the command ward were sealed by thick three-layered partitions, but those would all crumble if they were to take repeated attacks without someone to defend them. As such, violent skirmishes were unfolding between the soldiers who stood in front of the partitions and the lightweight Legion they were trying to keep at bay.

Antipersonnel/anti-light-armor buckshot mines went off, triggering in succession, and the roaring explosions tearing through the corridors shook the air as the sharp sounds of 20 mm anti-tank rifle fire came from another direction. Footage of multiple corridors and assorted status screens appeared one after another at a dizzying pace. Still looking at the holo-screens deployed around him in a semicircle, Vika directed an Imperial purple eye in Lena’s direction.

“If a single self-propelled mine gets through to here, it’s checkmate for us. The shock waves would get as far as here, and we’d have nowhere to run.”

“Understood,” Lena replied with a small nod.

The enemies were mainly self-propelled mines, but for the

command ward, those types of enemies were the most lethal. If a powerful explosive went off in this enclosed space, the shock waves would repeatedly rebound off the walls and intensify. Shock waves of such intensity would easily destroy the more fragile organs inside the human body, like the brain and the intestines.

In the last operation, Shin had used Undertaker as bait and exposed his own body to take down the Morpho, but one wrong step, and he'd have been in mortal danger due to the blast. Reading the report of his actions in that battle had made Lena shudder in terror, even if it had been his only option and there had been cover to deflect and diminish the shock waves.

"Is there any chance of infant-type self-propelled mines crawling in through the ventilation ducts?"

Ducts were an indispensable part of the facility, meant to make sure the people inside didn't suffocate, but at the same time, they were paths that directly connected to the outside and were a valid way to break in during a siege battle.

"The possibility of a child carrying in Greek fire...? Ever since this fortress was first built, the only places large enough for a human to pass through—be they a child or otherwise—were the rooms and the corridors. The duct interiors were a collection of tight, thin metal tubes. Even a single Eintagsfliege wouldn't be able to pass through them."

Incidentally, Greek fire was a sort of liquid propellant from the Middle Ages that used naphtha as its main fuel source. Thanks to its properties of not being easily extinguished by water, it was often used for naval combat and siege battles. It did beg the question, however, if the Idinarohk royal house had managed to buy enough of the commoners' ire to necessitate worrying over the possibility of a child carrying Greek fire in.

A blast sounded from afar, causing the air of the command post to tremble faintly. One of the codes signifying a buckshot mine went dim in one of Vika's holo-screens. The spot it went off in was an oddly well-guarded but consistently wide corridor, which made it easy to attack. However, it was a dummy corridor and led nowhere. Humans often favored attacking weak points and had a tendency to associate highly guarded locations with important, critical spots. The trap had been set up to take advantage of this

aspect of human psychology and control the enemy's actions, and the Legion seemed to have fallen for it, too.

Vika simply regarded it with a glance and scoffed. There were countless such traps strewn throughout the ward. But even these defenses were being depleted and consumed by the minute.

"A person will always be a nuisance to someone else, just by virtue of living. That's true for everyone, no matter how upstanding they may be... And so it is never a bad idea to be prepared. No matter the grudges it may end up buying you."

As the sun set, a snow-bearing wind began to blow, obfuscating one's field of vision with a faint curtain of white. Even the Ameise's compound sensors were somewhat impeded by it, so their fire, along with that of the Skorpion types, became significantly less accurate, making it easier to approach the walls. But on the other hand, the scathing snow also acted against the Juggernauts, making them trip over the stumps littering the deforested area. More and more rigs became incapable of moving.

They tried to retaliate against the unimpeded howitzer fire raining on them diagonally and horizontally by firing from below the walls, but the 88 mm tank turrets and 105 mm gun launcher were impeded by the serrated breastworks of the walls and hardly ever hit. Powerful breastworks, reinforced by specifically made armored plates. They hid the line of fire above the walls from harm while systematically deflecting the attacking side's fire—a perfect form of castle defense.

Slipping through the heavy, haphazard line of fire, Undertaker finally reached the base of the wall. Stabbing its legs' climbing irons and wire anchor into the frozen surface, Shin reeled the wire in, forcing his ten-ton machine up the wall. There were Legion above it, but the blizzard hid him from view. Theo's Laughing Fox joined him a few moments later. The two of them led the Spearhead squadron's vanguard platoons.

Anju's surface-suppression platoon bombarded a different point on the walls to draw the Legion's attention away from their comrades, the roar of their fire blowing away even the howling of the stormy wind. But for a moment, the wind died down and then

increased in intensity again, making the curtain of white temporarily cease.

Their gaze met with a self-propelled mine that was leaning out from the walls to peer down.

"...Get away! It's gonna cling to us!"

Purging the wire he didn't have the time to reel back and collect, Shin kicked against the wall and danced through the air. It was a harsh altitude even for the Juggernauts' highly efficient shock absorbers, which were made for high-mobility battle, but he had no other method of escape.

A moment after he jumped, the self-propelled mine crashed down before his eyes. It clung to a consort unit that failed to evade in time and self-destructed, taking them both out... An anti-tank mine type. It was capable of releasing metal jet that would penetrate even a Vánagandr's top surface armor if it were to cling to it. Needless to say, the poorly armored Reginleif was destroyed entirely.

Changing its stance in midair, Undertaker landed on its four legs. Shin wasn't used to maneuvering in a snowy battlefield with unique equipment meant to accommodate this terrain. The impact wasn't perfectly suppressed, transmitting from his climbing irons into the Juggernaut's internal mechanisms, and a worrying creak echoed through the cockpit as several parts cracked. A warning gauge lit up, accompanied by an irritating alert sound. He spared it a glance through narrowed eyes. His rear right leg's joint mechanism was partially damaged... It was still capable of moving, though.

A Skorpion moved its barrel in pursuit of them, and the Juggernauts that jumped aside fired at it mercilessly to keep it in check. They fired their rear gun mounts and autocannons without pause, not caring if the barrels would overheat and go out in puffs of smoke. A voice that was all too cold and calm by contrast—Second Lieutenant Yuuto Crow's voice—spoke through the Resonance.

"Nouzen, fall back. With the state your rig is in, you can't fight the way you always do."

"...But..."

Yuuto's rig, Verethragna, turned its optical sensor in his

direction. If a Juggernaut could speak, it would likely have a flat, mechanical voice.

"If you die, we lose our recon. Even after we made it in, the absence of your melee skills and extensive combat experience would put us at a heavy disadvantage... Fall back. Prioritize reconnaissance and command for now."

Shin held his breath for a long moment. Yuuto was right. But even if they weren't making any headway, retreating to the back of the line at this point irritated him.

"...Roger."

Lena looked on as one of the cameras on the surface level got hit by howitzer fire and went out of commission. Most of the main screen went dark. The footage of the battle surrounding the walls, the meteorological information outside, the predicted types and numbers of the enemy. All the information about what went on outside the base blacked out at once... The link line to the canopy's circumference at the top of the base—and the compound sensor units set up there—was severed.

"Reserve circuit activated... Milizé, it'll take a while before it's restored and online. Until then, keep the reports from outside—"

"No, it's fine. I have it all memorized!"

Lena didn't even see Vika wheel around to look at her with surprise. The enemy position Shin revealed to them. The positions of both sides, as detailed in the reports and outer cameras until now. The citadel base's structure and the surrounding topography. The wind speed and average visibility affecting the trajectory of shells. All of those had been memorized in her mind and then simulated to predict how they'd move.

This was easy for Lena, who had commanded squadrons while reconstructing a battlefield that was a hundred kilometers away. But this was a brigade—the number of troops was in the thousands. Even if she was breaking them down into smaller units, it required a massive number of simulations—which the Cicada responded to by operating with high efficiency. The countless quasi-nerve fibers lit up in purple, drawing random patterns across their surface.

"Scythe squadron, concentrate your fire on the third eastern

block's fifth wall. The Skorpion should try to head out as soon as it's done reloading. Lycaon squadron, work with the 1st Alkonost Company and fire at number seven. The 22nd Company is to provide covering fire. Spearhead squadron, you are to—"

The main screen flickered back to life, displaying all sorts of statistics. Sneaking a passing glance at it to confirm that her mental image of the battlefield matched what was going on, Lena resumed giving orders. It wasn't an impossible feat, but even without extreme concentration or immersion, she reconstructed and maintained this map of the battlefield in her mind and kept giving orders in succession even after the screen came back to life. That was likely thanks to the Cicada's assistance, but she'd also remained Resonated with an entire platoon at the same time. In which case...

It was then that a silver sparkle fluttered into their field of vision.

Everyone in the command post—Lena and Vika included—was caught off guard. A mechanical butterfly with wings as large as an adult's hand. An Eintagsfliege. It had likely sneaked in before the blockade started and wandered about before finding its way here. It had crossed over the bedrock, which had no sensors to speak of, and had since had no way of abiding by its parent unit's commands. It had likely found its way in on the verge of running out of energy.

The Eintagsfliege flapped its wings once, as if hesitant, identifying the presence of hostiles faster than the human eye could. It flew with its wings spread menacingly in front of Lena, its steely veins shining bright.

The Eintagsfliege... The type that disrupted radio, wireless, and all other forms of electronic communication by using powerful electromagnetic waves. And if a living body was exposed to those waves at close range, it would likely lead to fatal injury...

The shrill noise intensified by the moment. Burning the air around it, the Eintagsfliege emanated an even stronger light—

"—Daaaaaaaaaaaaaaaaaaaaah!"

Marcel rose to his feet and swatted down the Eintagsfliege with

the butt of his assault rifle. The weak-winged fly shape was blown back and slammed against the floor by that impact. It floundered on the floor in an attempt to set off again, but the mechanism of its wings was apparently damaged.

"...Well done, Second Lieutenant Marcel," said Vika as he pulled out a gun and, with one flowing motion, aimed and fired at the Eintagsfliege. A 9 mm submachine gun, which only a few of the United Kingdom's special forces carried. His shot accurately penetrated the Eintagsfliege's central section and shattered it to bits.

Lena released the breath she had unconsciously held the entire time.

That...was close. Entirely too close.

"Thank you, Second Lieutenant Marcel... You saved my life."

Perhaps all the tension left his body, because Marcel was even paler than she was.

"No... Uh, I just kind of...did it. I mean, if I couldn't do this, I wouldn't be able to look Nouzen in the eye..."

He sighed heavily, pulled back the chair he'd kicked away, and returned to his command console. The profile of his face, gazing into the holo-screen, made it clear he had already returned his mind to the battlefield. Lena recalled his personnel file—that before this young man became a control officer, he'd been a Vánagandr operator who'd served on the front lines, piloting a Feldreiß, but had to change his role due to lasting damage from a leg injury.

"...The next enemy is coming. Please resume command."

"...Shit."

An entire platoon of Sirins disappeared all at once as their Para-RAID targets vanished. Realizing the meaning behind that loss of signal, a young Handler swore under his breath. Once connected, the Sirins couldn't cut the Resonance on their own, and so there could be only one reason why the Resonance would be severed against the will of the Handler. The poor girls—incapable of sleep or losing consciousness—had died.

"Shit, shit, shit! Those goddamn inhuman Eighty-Six monsters!"

Using you as bait..."

For the United Kingdom's Handlers, the Sirins were not mere weapons. They were precious partners and trusted subordinates. Some even thought of them as their lovers, younger sisters, or daughters. These feelings were not limited to the Sirins, either. Handlers of war dogs and drones often developed empathy and excessive affection for their partners. Cases in which a Handler who'd had their drone destroyed rushed in for revenge for their partner were not uncommon.

And that was even more true for the Sirins, who had personalities of their own—albeit artificial ones—and were made in the shape of innocent girls. And those Sirins were now being consumed one after another. Ordered to lead a decisive charge under a precipitous hundred-meter-tall cliff where they would be exposed to concentrated fire, they acted as bait to be cast aside.

How could their Handlers' hearts not ache for them? It was only natural the Handlers would feel rage and indignation toward the Eighty-Six, who pushed the Sirins onward to act as their decoys. All the Handlers felt that way to some extent.

Had it been one of their northern brethren, then it would have still been tolerable. Had it been one of the royal bloodline, they might have even called it an honor. But to have a group of people of another race, from an inferior country, and of an inferior species who'd even cast their homeland aside, at that, use up and lead their beloved Sirins to destruction? That drove the Handlers to anger and resentment, so much more than the Sirins' deaths themselves.

Tears of rage and remorse trailed down their cheeks. For the sake of those foreigners, those inferior fools... For those *monsters*...?

"God...dammit!"

"Enough."

A single middle-aged soldier couldn't watch this display any longer. The rank insignia on his purple-and-black uniform was that of a captain—the commander of all the Handlers present.

"But, Captain!"

"Regardless of what we may think, that's what those girls are. People have volunteered to become those girls, knowing they

would be treated like this. It's nothing to get upset over... Besides..."

As the commander of the Handlers in this base, he was Resonated with the Republic military officer girl who was commanding the siege, and thus with her direct subordinate, the boy who served as the Eighty-Six's captain. And each of them was commanding over the battle while bottling up the pain of watching their comrades die. Their hearts also ached as they watched the Sirins, who weren't even comrades to them, fall to ruin.

It wasn't that they weren't sad over the loss... They weren't simply watching them be destroyed without a care.

And more than anything...

"...there are Eighty-Six dying out there, too. To save their commander and His Highness, as well as us... Hating or resenting them would be misplaced."

The Legion weren't falling for their feint of aiming at the main gate. Kurena had been searching for a decent vantage point to snipe from beneath the cliff but had been unsuccessful.

"Tch..."

It was only when he heard himself click his tongue that Shin realized he was becoming impatient and shook his head. Getting annoyed would get him nowhere. It would only lead to more deaths. But when considering the accumulated Alkonost and Juggernaut casualties and the rising number of the injured and dead—and in direct contrast, the ever-depleting amount of ammunition...

And the most frustrating part of all was that in spite of all those sacrifices, they'd made no headway whatsoever. The time limit was closing in on them by the second, and with it, a growing sense of frustration was bubbling up from the pit of his stomach. The enemy's reinforcements were drawing nearer, and the numbers of the enemies within the citadel didn't seem to be diminishing.

And it was exactly because he realized it, along with the fact that their numbers were only dwindling, that Shin could feel his

grip on his temper grow gradually limper. They didn't even have any way of knowing what was going on in the base, which was outside their reach.

And it appeared he wasn't the only one struck with impatience.

"Second Lieutenant Matoba?! Stop! Obey your orders!"

"But we have to keep firing! We have to keep them distracted, or— Gah!!"

A platoon had violated orders and attempted to scale a wall located at the southern tip, only to suffer machine-gun fire from both sides and fall. Shin thought he could hear the unnatural sound of them landing on the anti-tank obstacles that hadn't been moved and being run through.

The Thunderbolt squadron rushed through the Skorpion fire, suffering losses in the process, and clung to the cliff face, only to find the Ameise looking down at them from the arrow slits along the breastworks. Having confirmed the Juggernauts' positions, the Ameise retreated at once only to appear again, pushing something heavy in the process. Drum barrels, which they then pushed down the cliff.

"...?!"

The members of the Thunderbolt squadron kicked against the rock face to evade the drum barrels, and the next moment, they passed through where the squadron was and crashed down. Some were skewered by the anti-tank obstacles, and others crashed down onto the ground between them, the impact tearing them apart and squirting out something...a transparent liquid.

Following that, self-propelled mines dived down the walls. Falling one hundred meters headfirst, they made crash landings and self-destructed as they hit the ground.

A split second later, a wall of hellfire raged up toward the dull, snowy sky, standing between the squadron and the moat. The flames pushed aside the snow as they raged on, the updraft forming a maelstrom of sparks and snow, soaring up the lead-colored world in sparkling red radiance.

Even Lerche sat dumbfounded within Chaika and then shouted, **"Fire trenches...! They took the gasoline from the fuel bunkers!"**

More drum barrels tumbled down with dull thuds. Rebounding against a corner of the walls, they soared over the moat as they sprayed it with gasoline, further intensifying the flames. The

Legion operated on electricity and didn't require gasoline as a resource. They were free to use it without reserve as a stall tactic.

Yes, a stall tactic.

Shin shook his head slightly.

"We can't attack through here for a while... They used a nasty strategy against us."

The Juggernauts' armor was made from aluminum alloy, which was weak to fire, as were their wires, which included carbon elements. Breaking through those flames and climbing up the walls as they were exposed to heat was practically impossible.

A report came in from Theo:

"We've got a report in from the recon unit. The other walls are all on fire... I don't think the fire will last long under this snow, though. I guess we have to wait..."

"..."

In terms of rational judgment, that conclusion was correct. But time was on the Legion's side. The enemy's reinforcements were closing in while the citadel's defenses were being whittled down. With all that in mind, simply waiting and wasting their time would be a poor choice...

"...No."

Chaika, who stood beside him, looked up to the sky.

"The snow is getting stronger... This..."

The snowy sky grew darker still, and the snowflakes filling the air grew thicker. The decreasing temperature indicated that sunset was fast approaching. Fido towed away stranded Juggernauts and the charred wreckage of Alkonosts. Their energy packs, ammunition, and other consumables had been depleted for nothing as well.

Their losses were that grave.

"...might be all we can do today..."



The sun set.

The Eintagsfliege blanketing the sky reflected that day's final rays of sunlight with their silver wings, brilliantly illuminating the

heavenly sphere and the snow covering the earth. The world shone, its shadows growing all the darker.

A picturesque portrait of madness, without a soul on the battlefield having the leisure to see it.



With the sun setting, the fighting inside and outside the base died down. Confirming the information on the holo-screens, Vika sighed once and said, "Milizé, transfer command of the Strike Package to me for a while. Get some rest."

Leaving the command post vacant of a commander wasn't an option during combat. That was the reasoning behind Vika's instructions, but Lena shook her head earnestly.

"No. You rest first, Vika."

"Are you intending to take command of a defensive battle when you're fatigued? You have far less stamina than I do. So you should rest first... You've got bags under your eyes, and you look pale."

The fire trench's flames eventually succumbed to the snow, extinguishing over the rocks once nothing remained to serve as fuel. By that point, dominion over the battlefield had shifted to the all-consuming snow. It wasn't just falling heavily; the glacial wind blew it almost vertically, forming a white curtain that covered the Spearhead squadron's field of vision. It was a vicious blizzard, as if the heavens themselves conspired against them.

Moving forward was difficult, of course, and their optical sensors' night-vision mode and radar were ineffective in this weather. Even their weapon-control system's aiming reticle was blotted out by the white snow, and with them being unable to see the enemy if they were to run into them, and Shin's recon alone not being able to guide all the Juggernauts ahead, they had to agree with Lerche's statement that any more fighting that day would be impossible. Their Juggernauts and Alkonosts were in need of maintenance after half a day's worth of vigorous exertion,

as well.

They made camp deep between the trees of the conifer forest, where the blizzard was less fierce. Leaving Undertaker to the maintenance crew that greeted them, Shin heaved a single sigh into the cold, snowy night. Michihi walked over to him, the snow crunching under her feet as she approached. She was an Orianta, just like Kaie—the blood of the continent’s east was thick in her veins. She was a petite girl with ivory skin and black hair tinged with brown.

“Captain Nouzen, sir, the joints might freeze solid, and the auxiliary power’s voltage might drop, so any Juggernauts that aren’t on standby should be moved into the containers. The ones that are on standby are being warmed up with fires.”

As he looked back at her, Michihi continued with a smile heavy with fatigue.

“I’m from the northern front, so I’m used to fighting in the snow... We’ve got other people who served in the north, too, so we figured we could pass all the countermeasures along!”

“...Thanks. But don’t overwork yourself. Rest for tomorrow.”

“Yes, sir. You too, Captain.”

Michihi gave a flutter of her hand and walked away. Seeing her off, Shin walked away, too. A group of Scavengers led by Fido returned, hauling in the recovered wreckage of destroyed Juggernauts. Combat medics pried the canopies open and pulled out the Processors, placing them on stretchers. Passing at their side were maintenance crews carrying body bags in teams of two with their lips pursed. Behind the tent set up beside the medical dispatch unit’s combat vehicle, Shin could see a mountain of black bags piled up before he opened the Spearhead squadron’s heavy transport car. Anju, who had returned ahead of him, greeted him with a smile.

“Good work today. Kurena should be coming back from inspecting the rear guard any minute now.”

“Right.”

Inside the vehicle were Dustin, Theo, and for some reason Rito, who was there despite being from another squadron. Dustin handed Shin a mug full of instant coffee.

“...A lot of people died.”

"We Processors are still better off. Most of the Alkonosts died in our place."

"And we're running low on ammo, energy packs, and repair parts, too... Not having a supply line really is hard."

Kurena came back, grumpily brushing the snow out of her reddish-brown hair, and sat down with them after accepting a steaming mug from a Sirin that walked over to her.

"The Skorpion types retreated from the walls. According to what the prince says, they're being serviced by some weird machine on the surface level. There's only self-propelled mines on the walls right now. It's actually pretty funny—with all the snow piling on them, they look like snowmen."

She said this without a hint of amusement in her voice. Shin looked at her, noting her sour mood from the sense of urgency produced by a mix of fatigue and a day without any progress.

"They're servicing the Skorpion types' barrels... I suppose."

"Probably."

That was likely why the Legion had resorted to fire trenches to stall them. Howitzers were capable of horizontal fire but typically fired upward at a high angle. As the weight of the shells and the amount of gunpowder built up, the strain on the barrel increased. The Skorpion types had likely been driven into a situation in which they required maintenance after a full day's skirmish.

Watching the scene outside, Kurena shrugged.

"That Sirin just said that if we give the order, they'll go on alone. That they would take honor in their demise if it meant saving a life."

A faint yet noticeable tinge of disgust filled her golden eyes. The eyes of someone watching something they couldn't comprehend.

"Sorry, but I really do think they're creepy... From their perspective, so many of their comrades died. They suffered far greater losses than our people did. But somehow, they can still smile like nothing happened."

They could see countless young men and women receiving cups from the Sirins around the camp, giving words of thanks but not looking directly at them. And the mechanical girls showed no signs of concern, merely giving ill-received smiles to the

Processors as they continued tending to them.

"Forever fearless, eternally tireless, and never knowing pain, huh...?"

It was the same as the Legion they warred against.

"They really are mechanical dolls... They break but never die. You can't kill what's already dead."

"But...," Dustin said faintly, casting his gaze into his mug. "It feels wrong... It's the same as when we had the Eighty-Six do all the fighting."

Theo raised his brows in annoyance.

"So you're saying we're being the same as the white pigs here?"

His harsh tone made Dustin wave his hands apologetically.

"No, that's not it! That's not what I meant. I just..."

After his gaze darted about for a few moments, he lowered his eyes sullenly.

"I'm, um... I'm sorry."

"But...," Rito began. "...It really does kind of feel like we're looking at us from when we were in the Eighty-Sixth Sector. Especially back in the large-scale offensive, everyone died... clattering...just like that..."

"....."

Watching him hug his knees like a small child, Shin narrowed his eyes. So that was why he'd shown up.

"Do you pity them?"

"No... That's not it. I mean, it's like Second Lieutenant Kukumila said—they're creepy. They're not human. I don't really get what they are, so I'm scared... But having them clatter and die like that makes me feel bad."

It gave him the feeling they might trace the Sirins' footsteps and die the same way tomorrow. It was terrifying.

That sentiment, which wasn't spoken aloud, was one Shin wasn't familiar with. He was used to seeing those beside him dying... He'd had to get used to it.

"Do you want to stay behind in tomorrow's battle? It might be better if it's hard on you."

If the fear is that paralyzing...you're better being off the battlefield. All it would do is send you rolling into an early grave.

“...No.”

Rito shook his head harshly after a moment’s silence.

“No... It’s fine. We don’t have enough hands as is. And besides...”

Rito pursed his lips and continued, as if trying to inspire himself, and slightly as if it was a curse.

“...I’m...I’m an Eighty-Six, too.”

Going back to her room, Lena disengaged the Cicada and switched back to her Prussian-blue uniform. She then took up the steel-blue uniform that had been tossed onto her bed. Frederica had brought someone’s spare uniform. Having it on had been oddly comforting, but once the battle ended, it would have to go back to its owner. She probably shouldn’t leave any wrinkles in it. With that thought, she tried folding it with unpracticed hands.

But even though she was a soldier, for most of her life, Lena had put on only the clothes she had in her closet. And when she went back home, a maid would take her outfit and tend to it. When she spent time defending the Republic after its fall, Lena had had no choice but to learn how to tend to her own needs to some extent, but folding clothes still hadn’t been a concern of hers at the time.

Especially when it came to a man’s jacket.

After Lena fumbled with it for a while, Frederica, who had watched over her, sighed and snatched it from her hands. Since the number of people at the command post was currently larger than its intended capacity, the excess personnel had to share rooms in order to accommodate everyone.

“Hand it over. You are utterly hopeless when it comes to housework, aren’t you?”

“...Thank you, Aide Rosenfort.”

“That title is bothersome. Simply call me Frederica, Vladilena.”

Frederica folded the coat in an unexpectedly brisk, practiced manner. From what Shin had said about her, Frederica was about as skilled at cooking as Lena was, but apparently that wasn’t the case when it came to cleaning up.

“...You’re good at this.”

"Part of a Mascot's role is to function as a maid, after all. Albeit they do not yet let me touch the clothing iron, claiming it to be too dangerous."

After pausing for thought, she placed the folded jacket on the desk and regarded Lena with a sidelong glance.

"You were told to rest, no? I have brought us food, so sit down and take a break, I say."

"But..."

Frederica made a truly, utterly unpleasant expression.

"You truly are a slow one to understand, irritating girl, are you not...? The ones outside are also resting at the moment. Speak to Shinei for a bit, even if all you exchange is but a word or two."

They likely wouldn't last the five days until aid arrived. At most, they could last another two. Plagued by exhaustion and impatience, Shin left the container after concluding his debriefing to the commanders, which was filled with nothing but bad news, and he found Lerche waiting for him.

"It doesn't seem like the snow will cease tonight... You can leave the guarding to us. You should all get some rest."

As he directed a questioning look at her, Lerche seemed to get a grasp on his query.

"We require no rest, for we are mechanical birds."

"That might be true for you...but not for your Handlers."

"We require no command over us for a mere night watch. And some of the Handlers have prepared for a sleepless vigil."

...As would be natural. In siege battle, there was no guarantee night would mean hostilities ceased. Still, her offer was quite helpful for Shin as well. He could fight without a few days' sleep, but his efficiency and judgment would suffer for it. If he could afford to rest, he would.

"Thank you... I'll warn you if anything changes."

Lerche blinked once.

"Understood. I will leave one of us at your side... However..."

The way she tilted her head struck Shin as a slightly childish gesture. Vika would sometimes call her a seven-year-old, which implied she'd begun operating seven years ago. That innocent

gesture looked like one a child that age might make.

"...Sir Reaper. Do you mean to imply you hear their screams even in your sleep...?"

"Yes."

"That is..."

Lerche was at a loss for words. And her green eyes took on a concerned look, which gave the impression that a real human was standing before him. The eyes of a person whose heart went out to another person's pain.

"That must be quite difficult for you. I can only imagine what it's like, but having your rest disturbed at all times must be terrible torture for a human."

"...Not really."

This was an experience Shin had grown used to after ten years. The volume of the moans had almost doubled since the Sheepdogs had been introduced into the fray, but he had even grown used to that by now.

"The Para-RAID was originally a reproduction of a human's extrasensory ability. How good it would be if, in time, a mechanical limitation or reproduction of your ability could also be developed... Especially for us, who have no rest to be disturbed. We could set you free from the burden of having to warn others, without suffering any pain or strain."

Shin's brow furrowed in annoyance. Set him free?

"I didn't enlist to serve as a warning alarm."

"I am well aware. Your enlisting in the military came purely of your will. You will likely say you are used to this as well, just as you had no choice but to grow accustomed to riding that unruly bronco of a Feldreß... But if I may freely express my opinion, you push yourself too hard, Sir Reaper. As do the other honorable Eighty-Six. You have the precious gift of life. You should cherish your well-being more."

It was a truly odd feeling to hear someone who was merely a copy of a dead person's neural network—to hear Lerche, who was already dead—speak those words. As if they carried too much reality in them and were thus hard to refute.

Or rather...

"Why are you so fixated on us? To you, we're just soldiers from

another country.”

Lerche paused for a moment, as if considering her words.

“...Because we Sirins are, in a manner of speaking, like... Yes, like washing machines.”

“.....?”

Washing machines?

“Our role is to work in place of people. To partake in the labor of man is our purpose... And as a washing machine, watching the person before her toiling away as I sit unused, I cannot help but think, *If only they were to let us handle all this strenuous work and devote their time to loving one another, to taking care of their children, to bettering and enjoying their lives.* Because...”

...those are the privileges we can never enjoy.

As Shin stood silent, Lerche smiled at him. A proud, radiant grin, detached from how ghastly her words were.

“We are the marriage of machinery and death, merged together for combat. We have no future. All we have is the purpose given to us. But you are the living, and you have the freedom to wish for something in the future... You can wish for anything, unlike us.”

“...You’re...”

“Not human, yes? Sir Reaper, to you, who can hear the voices of the dead, are we...?”

As she asked him this with a bitter smile, Shin couldn’t bring himself to answer at once. He could hear the voices. Coming from the Sirins in front of him. Same as the Legion, those were voices of lament. Of those who died and were kept from where they were meant to be, of the ghosts who wept on and on, begging to be allowed to pass on.

The same voices as so many of his comrades who’d become Black Sheep. Same as the distantly related young man he never met... Same as the brother he avenged. Which meant they were dead. They were no longer alive. If Shin were asked if they were counted among the living, he could answer only with denial. They weren’t alive.

But for some reason, making that statement, telling them that they were only ghosts—that they weren’t human—was something he couldn’t bring himself to do. Because that would be

tantamount to stating that his brother and his countless comrades weren't human, either.

Perhaps sensing the internal conflict behind Shin's silence, Lerche shrugged.

"...I see. We seem like nothing more than moving corpses to you, after all."

"...You're not alive—that much is true. But..."

Shin trailed off, as he was unable to put his thoughts in order, and she simply smiled brightly.

"Do not misunderstand, Sir Reaper. I have no desire to become human, nor do I long to be treated as one. I am Prince Viktor's sword and shield and therefore have no need for a human's fragile heart and body... However..."

Lerche looked down at her body and smiled faintly.

"...I am not the person I was based on. I am but the final vestiges of that person's brain. And that alone hurts my master... And having realized that makes me feel... Yes, it makes me feel lonely."

"....."

Unlike the other Sirins' voices, the voice crying out from within her wasn't male. It didn't belong to a United Kingdom soldier—who were only adult males—which meant it likely wasn't someone who'd died in battle. And she had golden hair, indistinguishable from that of a human's, and didn't have a quasi-nerve crystal embedded in her forehead.

She was probably fundamentally different from the other Sirins, which were to be used up on the battlefield in place of humans and were thus made distinct to mark them as such substitutes. Her appearance made it clear that she wasn't intended for battle but was instead created with the intent of resurrecting one particular person.

"...Who were you...originally?"

Vika, I won't leave you behind...

Yes, the voice echoed its final thoughts but was at the same time repeating its wish to pass on, same as the voices of countless other ghosts. It was Lerche's voice, albeit a few years

younger. A youthful girl's voice, like the chirping of a bird.

"Lady Lerchenlied... She was His Highness's milk sister."

So it was someone Vika knew... Same as his mother, who'd passed away soon after his birth.

The Serpent of Shackles and Decay—Gadyuka.

Such was the name of the viper, owing its reputation to the chain-like pattern of its scales; its venom, which was so potent it could corrode human flesh; and anecdotes that spoke of how it was born by eating through the flesh of its parents, thus killing them. This was apparently a superstition stemming from the fact that it was an ovoviviparous animal. It devoured those close to it simply by virtue of being alive.

For the first time, Shin felt he understood the feelings of that serpentine prince, who willingly bore that name. Because carrying the burden of those closest to him dying was a feeling that stirred Shin's heart just the same—one that was all too familiar.

"From what I hear, she accompanied His Highness during his first battle and passed away there... This body was made in the image of Lady Lerchenlied."

—Does Lerche long to go back to where she belongs?

Vika had asked him that... Because he was the one who'd tethered and bound her to this world. And that was the reason behind his expression when Shin confirmed that she did.

"His Highness created me to resurrect Lady Lerchenlied. But my body and soul are not Lady Lerchenlied's, and I possess none of her memories. That alone...is terribly frustrating."

"...My apologies for telling you something so strange. Please forget this conversation... And...have a good night."

And with a cheerful smile, Lerche left, and Shin returned to the armored transport vehicle. The Juggernauts were stored in the vehicle as well, but the other platoon members hadn't returned yet. They were likely talking to their comrades from other squadrons.

The Para-RAID turned on suddenly, and a familiar voice like a silver bell addressed him timidly.

"—Shin?"

"Lena. What...?"

Shin was about to ask something and then gently fell silent. Lena's voice didn't have any shades of panic that indicated a state of emergency. It was the same slightly relaxed tone she'd had when she'd Resonated with them every night at that barracks. He involuntarily let slip a wry smile—he could tell something that had been unconsciously kept tense within him had suddenly loosened.

Lena had apparently sighed with relief. Shin directed his question toward the relieved sensation across the Resonance:

"Are you all right?"

"We're fine, somehow. Thanks to you guys keeping the Legion's main force occupied."

She then asked earnestly, **"You're cold, aren't you? Frederica said there's a blizzard raging outside..."**

"It's nothing we can't handle. The Federacy's front lines get pretty cold in the winter, even though it doesn't quite compare to how chilly it gets around here. And we have gear to accommodate."

The armored transport vehicles were originally meant for long-distance transportation of Feldreß. They were built to serve as quasi-barracks for when the time came to stop to make camp, and while they were far from an ideal and comfortable lodging, they were good enough to rest in. If nothing else, it was far better than the cheap seat of that aluminum coffin's cramped cockpit, which had been designed as if to spite the very idea of ergonomics.

"Was anyone hurt...? I'd forgotten, but I can't see that much with just the Para-RAID."

Shin's voice possessed that same serene, levelheaded tone it always did. But it occurred to Lena that if he was to try to hide the truth of it from her...if he was to conceal it to spare her the pain of knowing someone was injured or killed, she'd have no way of knowing.

"It's the same as two years ago, isn't it...? I'm inside the walls, and you guys have to endure all the fighting. If you get hurt or suffer...I won't ever know unless you tell me."

And she shut them away in the battlefield to ensure her own survival. The reason Shin and the others were fighting was partially because they lacked the supplies to have everyone retreat and partially because they would leave Lena and the others behind to die in the fort if they did. Because they'd stopped out of concern for them when the citadel fell, and they'd been trapped in the blockade because of that. If Lena and the others hadn't been here, they surely would have been able to retreat to safety.

If anyone was hurt...if anyone was sacrificed for this, it would all be their fault. In which case, at the very least...

"You're in the most dangerous place of all right now, Lena. And it's not like you're not fighting, too," Shin replied, perhaps aware of her inner conflict, perhaps not... It was this effortless kindness of his that allowed Lena to stay by his side.

Before she knew it, a bitter smile played over her lips.

And if so...if that's the case...it should be me who says these cold words.

"—Shin. If..."

What Lena said next filled Shin with so much anger his hair stood on end for a moment.

"...If you think you might get wiped out, I want you to forget about us and retreat... And if it's impossible for all of you, then at least some of you—"

"I'll get mad, Lena."

He cut her off. That was one thing he couldn't stand by and let her say.

"Telling us to abandon you and run is an insult to us. So even if it's you, Colonel... Even if that was an order, I won't listen."

"I'm not telling you to run. A strategic retreat is a perfectly viable strategy... And it's not like you've never abandoned things before. You've done it to defend your friends who were still alive. Like when you told Anju not to go after Kaie's head."

"That's... Tch..."

He reflexively thought to deny her argument but fell silent when he realized he couldn't. It wasn't just Kaie. There were

others he couldn't save...so many others. He couldn't let many people die for the sake of saving one person, and he wouldn't risk his own life to cover for another, either.

"You're right, but..."

"I'm not blaming you. You're a squad captain, so it's only natural you'd pick the path that would save the most lives... This is the same. I don't want you to apologize for those choices."

"...!"

It wasn't the same. He had discarded things he deemed unnecessary more times than he could count. But they weren't the same as leaving her here to die. It was true that for Shin and the Eighty-Six, comrades would eventually die. Everyone on the battlefield would disappear. Just like his father and mother and brother, who'd gone to fight ahead of him. Like the 576 comrades he took with him away from the Eighty-Sixth Sector. Like Eugene, whom he'd put out of his misery.

Even Fido, who had fought alongside him longer than anyone, had left him at one point. The only difference was who left him first, but everyone eventually left Shin behind and went ahead, despite none of them wishing to die. And yet, she told him to abandon her so easily. Unbeknownst to her, her words tried to pry away the first wish he'd ever made.

I want to show you the sea, he wished.

Yet the words he heard were *Leave me behind*.

If she was his comrade, if she fought by his side, that may mean that even Lena would eventually leave him behind as well. He knew that well enough. Or...he thought he did. Yet, despite that, he couldn't acknowledge it. He didn't want to even consider the possibility of losing her...

"...Shin."

"No."

As he snapped back at her reflexively, even he couldn't help but realize...that his voice sounded like that of a lost, hurt child throwing a tantrum.

CHAPTER 4

EX MACHINA

Trying to overturn death was taboo. That was something he thought he'd learned already on the day he'd tried to resurrect his mother. His failure had resulted in a part of her being lost forever. A child longing for his mother was a natural emotion for humans. And lamenting someone's death came just as naturally.

But if a child were to attempt to resurrect their dead mother, then it would be the act of a monster or a madman. That was something he could never know for as long as it went unsaid. And even once the words were spoken, he couldn't, from the bottom of his heart, fathom what was so horrible about it. It likely meant that he was a monster, devoid of rationality.

And he should have known it by now.

The indignation and pity in his father's eyes as he bore witness to the dissected body of his wife, and his child who had done the dissecting. The strength of his brother's embrace as he wordlessly hugged that child, who stood stock-still.

And the tears of his milk sister, who clung to him as she wept bitterly.

So he may not have understood, but he did learn that lesson and make that oath. That was a sin. A sin that filled his precious father, brother, and *her* with sorrow. So never again would he try to defy the border separating the living from the dead...

However.

“Vika... Hey... Are you okay...?”

That same girl now lay before him, crushed beneath rubble.

“...Lerche.”

The words spilling from his lips without regard for his will felt as if they were spoken with someone else’s voice. His throat was parched, suffocated by the mineral dust in the air. A shell’s explosion had smashed a slab of concrete and made it crumble over the frontline base, covering half the room. It was the result of a direct hit from a Skorpion’s 155 mm shell, which had enough firepower to reduce both a Barushka Matushka and a fortified concrete bunker to bits.

She was crushed under a piece of rubble that was taller than his then-ten-year-old self, as if someone had attempted to cut her in half right across her midsection. A raw, unfamiliar stench tickled his nostrils, which had only known the sterilized scent of the palace until now. A sticky substance oozed from beneath the rubble—blood.

Even as she was tormented by the unimaginable pain radiating from her lower half, her pallid pure-white face and her bloodied red lips contorted into an earnest smile.

“Thank goodness.”

“...Why...?”

He instantly regretted that his question unintentionally overlapped with her statement. Those were her final words. They couldn’t be interrupted or missed. But he couldn’t stop the words from leaving his lips.

“Why did you protect me...? I’m the one who should’ve been crushed under this rubble...!”

Lerche was lying buried at the spot where he’d stood moments before the collapse. He knew—he couldn’t help but know—that she’d pushed him out of the way. Was it because he was royalty? Because it was decided that he’d be her master? Did she really throw her precious life away, clinging to such a stupid reason...?

“What do you mean, ‘why’...?”

Tilting her head, Lerche smiled painfully. As if wondering how he hadn't realized it already.

"You're the most important person in my life, Vika..."

"...!"

The girl who had been chosen to serve at his side for the rest of her life soon after she'd been born. From the moment her mother became his wet nurse, her life had already been sold off. Any loyalty, any emotion she harbored for him was merely propped up to support that. She must have known.

But Lerche smiled. Without regard for anyone's intentions, her eyes unfocused from the blood loss, as if she were dreaming.

"You know, Vika, I may be a serf, but I love this country. I love this country's long winters and sparkling springs, summers, and autumns. This is the place where I was born, you know? It's where I lived with you until today.

"So please..." Lerche said, looking up at him with dreamy eyes that were unable to discern him—or anything else—any longer.

"...keep protecting it. Keep protecting our homeland."

"...I will."

What other answer could he have given? He himself may have loved the country's seasons, but he felt no lingering attachment to it. He had no sense of pride or belonging to the country he was born and raised in. Yet the girl dying in front of him, the girl who was his classmate, his childhood friend, his milk sister... The girl who stayed by his side even as people said she was merely the Serpent of Shackles' plaything.

She was always with him. Such a thing was second nature. And he'd never thought he would lose her.

"I promise. I'll protect this country and its people... So..."

Faced with a loss that couldn't be reversed, he was terrified for the first time in his life. Being left behind scared him so much more than her death, and that selfishness, the coldness of his own heart, made him shudder with fright.

It was then that he realized that without a doubt, he was not human after all, but a coldhearted, man-eating viper. And he couldn't help but long for it—to repeat the mistake he had forbade himself from ever making again.

"So, Lerche... Would you stay by my side from today on?"

Don't leave me behind.

Lerche's eyes widened for a moment. If there was even a hint, a trace of hesitance or fear in her eyes, he may have given it all up. But the loyal girl nodded. She bore her own corpse before him, accepting his all-too-selfish request to allow him to make her into the living dead with a smile.

"I will..."

My lonely Prince Charming.

Those were her final words.



When Vika awoke from his nap, he was greeted by the usual sight of the thick concrete walls that distorted one's sense of time. He'd gotten used to this faint darkness teeming with silhouettes clad in the United Kingdom's purple and black, the Federacy's steel blue, and the Republic's Prussian-blue uniforms over the last three days. The air, stuffy from the minimal ventilation, was thick with an atmosphere of exhaustion.

It'd been three days since the siege had begun, and they were nearing the end of their rope. Perhaps owing to the odd dream he'd had, Vika sighed lightly.

He was presently in a frontline base's pillbox, just as he'd been in back then—albeit that one had been much smaller in scale and much worse equipped than this one. The United Kingdom was a militaristic country, and the Idinarohk line stood at its peak. They served as vanguards on the battlefield, and they always stood at the front lines to learn how to do so.

And it all happened when, abiding by that custom, he was sent to the southern front. Vika wasn't being shunned in particular. Everyone, with the exception of the king and the heir first in line for the throne, was equally sent to war. And so his uncle, the royal prince; one of Vika's elder brothers, who was also a prince; Vika's sister, a princess who was five years his senior; and one of his cousins, who was also a princess, had all died in battle.

He'd slept by resting his back against the wall, which had made his body stiff, so he rose to his feet to stretch. He really did hate these kinds of dark, cramped spaces.

It reminded him of when she'd died.

"Lerche."

With his throat still dry with traces of the dream, he whispered the name. To connect himself to the quasi-nerve crystal attached to the girl resurrected in her image. It had been placed within the girl's body, behind the neck. Where no one would be able to remove it.

So he would never have to let go of her again.

"Are you listening, Lerche?"

Her immediate response came through the Resonance.

"Of course, Your Highness... Your orders?"

The Sirins never slept. They might power down for the sake of having their precision mechanisms tuned or for maintenance, but it was different from a living being's slumber. Their artificial brains did not build up the chemicals that caused fatigue, and they did not require sleep to organize their memories.

Simply put, they weren't human.

"Give your report first. What's your status out there?"

"We have little remaining ammunition and energy packs. We've lost forty percent of our Alkonosts. The Juggernauts haven't suffered as many losses, but...the Processors are nearing their limits."

"Naturally. The attacking side gets depleted first during a siege. In terms of both manpower and supplies."

This sort of battlefield was rigged against the attacking side. The defending castle had lodging facilities and defensive measures on its side, while they had to sleep out in the cold, open air. Modern tech may have made sleeping outside a bit easier, but they still had to spend three days in a snowy battlefield they were unfamiliar with.

"What about the Legion reinforcements' position? How far did they get according to Nouzen's recon?"

"As of sunset yesterday, they've reached the phase line Lark and stopped there."

"Their getting as far as Lark was within predictions... But I suppose I must take my hat off to the Federacy's Vargus. They're

holding on well.”

“By your will... Also...”

Lerche seemed hesitant to continue speaking.

“...Nouzen’s fatigue is the most worrisome of all, I believe. To think he cannot turn a deaf ear to the wailing of the dead even in his sleep... Though he hasn’t said anything, I do wonder if our presence causes him additional strain.”

If this goes on for much longer, he just might break.

Vika nodded, picking up on the implied concern in her voice.

“We may have to think of some countermeasure when it comes to deploying you during cooperation with the Eighty-Six... I’ll ask him myself after this is all over.”

Vika realized that it was no wonder Lena was so anxious. Because of the strain, that headless Reaper had lost his ability to discern whether he was hurting. Shin had no desire to make others cry but lacked the understanding of what made them cry in the first place.

“Our side’s scarce on ammo, too. We’ve told the rescue force to hurry, but it’ll still take them time... We’re at our limit.”

Today and right now would be the watershed. All that remained was to push in and crush the enemy. Thankfully, the enemy’s guns were sufficiently exhausted to allow for that.

“We need to finish this. Show them your duty and dignity.”

Lerche seemingly smiled.

“By your will... Your Majesty?”

“Hmm?”

“Please do take care. I will be by your side soon enough.”

Vika’s eyes widened for a moment. Cutting the Sensory Resonance, he looked up and smiled wordlessly. All that he saw was the gloomy artificial ceiling. And though the girl wasn’t beyond it...

“Just where did you learn that one, you blasted seven-year-old?”

He’d never had Lerche go through the process of having her memories wiped. That procedure had been added only when the Sirins went into mass production, after a handful of prototype Sirins had been produced. If a human consciousness was placed inside another body with the memories of its final moments intact,

it would collapse and never start up again, so the procedure was implemented only after that became clear.

Lerche had never undergone the procedure, because it hadn't existed at the time, but the consciousness and memories from when she was alive hadn't remained in her to begin with. At first, Vika had been terribly disappointed and had despaired... At the same time, he'd been just the slightest bit relieved.

Because he was also deathly afraid. What if she were to complain—to tell him she actually didn't want to be confined like this? That she had no memories, not a trace of her old personality...that even her manner of speech was entirely different from what he once knew, was a blessing for him.

At times he thought maybe she actually did remember everything, but despite that, she still changed her tone and mannerisms. All so Vika wouldn't remain bound by her memory. So that this time, he could truly use and break her, like a tool.

Because his milk sister was that much of a worrisome girl. Meddlesome to the point of foolishness.

"...Lerchenlied."

This world isn't the least bit beautiful anymore. Spring will likely never come to a world without you. Still... You wished for me to defend it. And for as long as I remember that, I feel like I can still meet you.

"I will fulfill that promise... Now...and as many times as it takes."



"Sir Reaper."

He knew it was her. But hearing the wailing of a ghost so nearby still made Shin rather uncomfortable. They were in the container that served as their conference room. Shin was rearranging the Legion's organization, which had changed somewhat overnight, on the operation map, raising his head only to face Lerche.

"A fine morning to you. I was just thinking of coming to wake you up."

“What happened?”

He'd noticed only after saying it and clicked his tongue. They were on the battlefield, and it was the morning of a battle. It was only natural to be wary of anything unusual, but his voice was thornier than he'd intended—fighting for these three days had put him more on edge than he'd realized.

“...Sorry.”

“It's fine.”

Lerche shook her head gently. There was no trace of exhaustion about her, and she continued speaking with her usual snow-white face.

“This is true for all of you, however...you seem especially tired. Your face is quite pale.”

“Yeah...”

He'd thought he was used to it, but being exposed to the incessant screams of the Legion at all hours of the day was wearing him down. Adding that to the cold, the frustration from the fruitless skirmishes, and the ever-approaching time limit...it was a small wonder that he'd woken up sooner than expected.

“The human body truly is an inconvenient thing. You cannot function without sleep, cannot move without eating, and can die if you lose so much as a single limb. It's as if you were made unfit for battle. No... Perhaps it would be more apt to say that war has left humankind behind.”

To begin with, war and loss of life went hand in hand. The deafening roar of cannon fire, the severe oscillations and heat emanated by tanks and Feldreiß, and though they were no longer in use, the supersonic speed of the fighter jet—as humankind sought to gain further armor, destructive power, and speed to enable those machines to destroy each other more efficiently, weapons had gradually changed into things that harmed their wielders.

Lerche spoke from a mechanical body that could feel no pain, that knew no slumber or hunger, that could fight even after losing limbs so long as its propulsion system and central processor remained intact.

“Shouldn't you have entrusted war to us a long time ago?”

Shin regarded Lerche with a fleeting glance. So humans had

become nothing more than a burden for their weapons. Was that the way of it? What limited a manned weapon's mobility was the brittle human body inside it. The need to include a cockpit increased its weight and size. And if taken to an extreme, with the exception of their nervous systems, humans were just sacks of fluid that weighed an extra several dozen kilograms. And the brains that operated those nervous systems would grow dull with fear and exhaustion. As weapons, they were utterly defective.

Yet still...

"We would be...no better than the Republic."

Lerche blinked slowly, with the movements of a windup doll that didn't understand what it had just been told.

"We truly aren't human in any way."

"I don't mean that. Whether what sits inside a weapon is human or not has nothing to do with it. Shoving all the fighting onto someone else and fleeing the battlefield, throwing away the strength and will to fight, putting your fate in someone else's hands. That's just...pathetic."

That was their source of pride as Eighty-Six and what set them apart the most from the "white pigs." It wasn't the color of their hair or eyes but their way of life. Living on the battlefield with nowhere to run, relying only on one's own body and one's own comrades. Deciding to never put one's fate in the hands of another. That was what made the Eighty-Six who they were. It was their proof of being.

Lerche suddenly giggled.

"...Pathetic?"

And the tone of her laughter was clearly...mocking.

Shin reflexively glared back at Lerche, who raised her chin and laughed. As chuckles escaped her throat, she squinted her eyes, but not out of laughter.



"Pathetic. Pathetic. *Pathetic*, you say? *That's* your reason to fight...? That's it?"

She laughed as her eyes burned with naked hatred and wrath.

"Of all the reasons you could pick, you choose 'because it'd be pathetic not to'? You choose to live on the battlefield simply because you don't want to appear...pathetic?"

And at that moment, Lerche smiled like a blooming flower.

"...At least you're alive."

Her voice was like the chirping of a bird but at the same time had a certain viscosity to it. The voice of the dead—thick with loathing and envy.

"You get to be alive. Unlike us, you haven't died yet, so you can recover and fix things as many times as you want. You can redo anything and start over!"

Overwhelmed, Shin had instantly fallen silent as Lerche slammed him with fervent remonstrations. Though there was a smile on her face, there was fire in her green eyes. Shin's ability allowed him to hear the voices of lingering ghosts as they repeated the thoughts of their final moments. But he couldn't hear what thoughts their mechanical minds harbored after death. That held true for the young man who shared his kinship and blood, however distantly, and even for his own brother.

And therefore, Shin had never heard the thoughts a ghost had after it died and became as such. Those emotions—envy and rage toward those who were still alive.

"You say you'll fight on, but you won't discard your body, which isn't fit for battle. You won't relinquish the eyes that let you see others, the voice that lets you speak to them, the hands that let you touch them, the body that lets you live alongside them. Even though you wish to be with someone... Even though you wish to find happiness with someone!"

Her condemnation reverberated like a scream: The same couldn't be said for her. After her death, she could not live alongside anyone. She could not become happy.

And you, who can still do all those things... You, who still live... so brazenly...

How dare you.

Lerche smiled, oh so cheerfully. A ghastly smile dripping with hatred.

"You're still alive. How dare you?"

You can still find happiness with someone.

"....."

And Lerche smiled—her expression almost indiscernible from weeping.

"The only ones who should die are us: the ones who have long since died already. You humans are still alive. Anything you lose, anything that gets taken from you, can be reclaimed."

Another deep-crimson shadow appeared in the container's entrance.

"Lerche."

The owner of that voice, as delicate as the moment snow crystallizes, was Ludmila. A tall, graceful Sirin with hair far too red to seem natural.

"I've gathered everyone. Preparations to sortie are underway."

"Roger that. Sir Reaper, please have all hands on your side prepare to set out, as well."

"...All hands?"

Lerche regarded Shin's suspicious question with her usual soldierly smile, all too unsuitable for the face of a young girl.

"I told you I would inform you if something happened, did I not...? His Majesty gave his order. We will now go on the offensive."

When she awoke from her slumber, the first thing she sensed was a malodorous smell infiltrating her nostrils. It was a scent that dredged up a certain memory she didn't wish to recall. An old memory from eight years ago—and a fairly new memory from one year ago.

The scent of burned metal and charred flesh, of decay and

death. The smell of the war dead's remains, which were hidden in the back room, gradually decomposing.

Shaking her head, which was still dull from fatigue, Lena sat up. She slipped her arms through the sleeves of the steel-blue jacket she had borrowed and brushed her fingers through her hair before she left her small room. Frederica, who'd stayed with her in this room for the last three days, was understandably exhausted and was wrapped up in her blanket, completely still.

The scent of blood trailed after Lena as she walked down the corridor. The stench of the dead hung heavily over every corner of the underground command ward.

She didn't even feel any disgust toward it at this point.

Because it was much better than the two-month-long defense during the large-scale offensive of last spring, when most of the Republic's citizens died. It was during the hottest day of the summer. The smell of burning metal, the suffocating, dizzying stench of countless remains that weren't collected—much less buried—during that seemingly endless defense.

She'd grown used to it soon enough—learned to not mind it. People can get used to anything, even things they never have to grow accustomed to. And all too easily, at that. She crossed the door to the command post, biting into her pink lips.

Something was wrong. All the command personnel were in their positions, including the ones who should have been resting. And their faces were all contorted with stress and suspense, as if they'd been ordered to swallow poison. As if they were steeling themselves before a decisive battle.

"D-did something happen?!" she asked hurriedly, and Vika gave her a fleeting glance.

"You're up, Milizé... But see if you can wake up Rosenfort, as well, and prepare for command. We'll be launching a general offensive on the southern wall within the hour."

"A general offensive? On whose order...?"

"My order, of course."

As she looked up at him in surprise, Vika shrugged casually.

"We're at the end of our rope. If our forces get diminished any further, we won't even be able to launch this offensive. We have to strike before they stomp us out."

"Attacking blindly would only result in more losses. Losing our temper right now would be suicide—"

"So would holing up and defending ourselves blindly. It's just a difference of whether the losses come sooner or later. If anything, staying on the defensive guarantees we'll be wiped out."

Trying to minimize their losses was pointless. Even if they tried to hole up and defend themselves, they'd be destroyed before help arrived. Saying that plainly, Vika gave a bitter smile.

"There's no point in trying to sugarcoat the situation, Milizé. It's not that I've gotten desperate, and I'm not betting on us turning the tables with a miracle, either. It's not as if we've been cornered that badly yet... We may still emerge victorious."

But the expression he wore made it seem as if he'd merely noticed that the rain was stronger than he'd anticipated, Lena couldn't believe him. He had to have understood the situation they were in. Aid wouldn't arrive in time, and they wouldn't last if they remained on the defensive. So their only choice was to attack. But...

"The casualties."

"There'll be casualties, yes. Many casualties, even. But, well... that's just the way it goes."

"...What?"

As Wehrwolf turned around in reaction to its sensors, Raiden regarded the Barushka Matushka stepping forward from the darkness of the hangar with a raised eyebrow.

"It's His Majesty's order. All Handlers are to tend to defending the entry points."

The voice of a man a few years older than Raiden, from behind the Barushka Matushka's unsullied armor. It was a voice he'd heard a few times—one of the Sirins' Handlers.

"Once the unit outside breaks through the walls, you guys go and regroup with them. We'll keep things in check over here... His Majesty is our frontline commander, and those of us Handlers who abide by him can fight, as well."

Raiden felt Shiden scoff through the Resonance.

"You've got moxie—I'll give ya that. But my Brísingamen unit is Her Majesty's personal guard. I won't leave her defense to you outsiders. Sorry,

werewolf boy, but your unit's gonna have to go alone to greet your master."

"...Okay, first of all—"

He swallowed the obvious gripe of *Who're you calling my master?* for the time being and instead asked a different question, putting aside the unpleasant image of the face Shin would have made if she'd said that sentence in front of him.

"Who's commanding the Sirins if you're here?"

"Why did you shift command of all the Sirins to yourself, Vika?"

"Because I'm the only one who can do this."

His reply was rather concise.

"I believe you once told me that considering the strain it would cause, controlling two hundred units at once was your limit."

"And that's why I won't be the one enduring that strain... This connection won't be for combat purposes and will be good enough for the work ahead... Besides..."

The prince of the north spoke casually, as if he was speaking of something insignificant. With the pride of the clan that had trampled over countless commoners for centuries.

"...this is my duty. Lerche, are you prepared?"

"Of course. We're ready whenever you are, Your Highness," Lerche replied, her green eyes turned toward her optical screen. She was inside Chaika's narrow, dark cockpit, which was made to accommodate the Sirins' bodies. The Cicada's silver threads sprouted from behind her, crawling along her slender neck and slithering beneath her clothes. It connected to the power-supply ports added across her body, deploying and activating across her skin, which produced no bioelectric current.

She would be functioning as a relay for the majority of the large-scale Resonance that was about to take place, making it possible by shouldering the burden... This wasn't something she'd been ordered to do. This was something she wished for. Her master would have handled this all on his own, not minding the strain. But Lerche didn't want to let him do that.

My body is my master's sword and shield. Defending him is my

pride, and letting even a single hair on his head come to harm would be the greatest shame imaginable.

Lerche glared at the fortress crawling with her sworn enemy, the Legion, and spoke. At her side was Undertaker, and behind him was a small army of Juggernauts. Before them, the remaining Alkonosts stood lined up in an attack formation, as ordered by their master.

The truth was, she didn't want the Juggernauts to be part of this battle, or any of the battles that had already happened.

This is the garden of war. It belongs to the birds of death.

"Your orders, please, oh King of Corpses."

The United Kingdom's and the Federacy's Feldreiß stood overlooking the snowy field littered with the remains of the Alkonosts that had been destroyed over the last two days and the fortress beyond it. They stood in a line formation, with the remaining Alkonost units in a column taking the front, and the Juggernauts behind them. They were divided into squadrons according to the attack order discussed during the briefing, where it had been decided the Juggernauts would go after the Alkonosts.

Shin thought it was an odd formation. The Juggernauts were in the center of it, with the Spearhead squadron taking the lead right behind the column of the Alkonosts, in a position to view the whole battlefield. It was a formation that faced their target, the southern cliff, with almost foolhardy honesty. And the Alkonosts up front were far too close together. It was an extremely narrow formation.

A column formation was made to focus one's military might and break through enemy lines, but what stood before them wasn't a mobile weapon but an impregnable cliff. A trench was dug before that cliff as well, and it was easy to imagine them being held back by it.

They carried logs and stones, likely gathered between the battles, and stuffed them into empty containers that were forcibly connected to spare Juggernauts' wire anchors by a forerunner unit, and it seemed the plan was to use those materials to fill up

the moat and climb up that way.

The strength of a column formation lay in its impact, gained by concentration of military might and its speed. But the moat and the wall behind it would stop its momentum and render the charge ineffective. Worse still, their stopping could make it hard to continue fighting, thus resulting in a fatal delay. And such a dense formation would be reduced one by one by the Skorpion types' concentrated fire.

What...were they thinking?

The outline of the operation had been explained, of course, but Shin's Federacy forces had only been given the role of getting over the walls and handling the interior. They'd been told nothing about the method they would employ to get over the walls. All they'd been told was to let the Alkonosts handle it—and nothing else.

As Shin stood there puzzled, a single Alkonost rose to its feet across from him.

"...Sir Reaper."

It was Ludmila. Her rear canopy was open, and she stood on the ascension ramp, her body exposed to the snowy wind. And as she looked into the field riddled with the remains of her comrades and at the fortress ahead, she spoke.

"We may be the dead who were once human, but that means we are human no longer. Our bodies were made by men, our hearts assembled by them—we are mechanisms designed to prevent needless loss of life."

".....?"

That was something he had heard many times already, both from their creator and master, Vika, and from the Sirins themselves. The Sirins were originally the war dead. The United Kingdom's defense system was based upon recycling the war dead so they prevented further people from dying. But why bring it up now, before the operation...?

"We exist for the sake of humankind."

At the edge of his vision, a countdown began. A countdown that heralded the beginning of the operation. All the Processors, Shin included, were strictly ordered to not interfere with the Alkonosts.

"And so this is..."

As the numbers ticked away, Vika suddenly realized the girl sitting in the vice commander's seat next to them had the ability to see the present of people she knew.

"Rosenfort, close your eyes for a while. Not just your ability but your real eyes."

Surely even Vika realized that *this* wasn't allowed. He didn't want to see any more children have their psyches shattered—children who, unlike him, hadn't been born monsters who had been broken from the start. If it were up to him, for as long as he lived, no child would suffer the way he had.

Because if they couldn't... If children who were born human were to be so easily broken and become monsters that would never obtain basic human joy...then a broken monster like him could never know happiness...

He had to be surprised at how selfish he was even now, snickering faintly at his own viciousness. In the end, he could only pray for someone else's joy for his own sake. Such were the thoughts of a cruel, despicable, coldhearted serpent.

The countdown kept on ticking. Regarding it from the corner of his eye, he parted his lips.

"Gadyuka to all Alkonost units... Commence operation. Now—"

The man-eating serpent: Gadyuka.

Yes, indeed. I was always a broken serpent. There are no more emotions left in me to break. That was probably a mechanism humankind as a race planted within me for this purpose.

In the moments when madness would wash over sanity, when humans would be unable to retain their reason, he would cut through crises in their place. That was what he was made for... Just like the dolls he created, that stood as an affront to humanity.

Show them the pride we monsters possess, you who are not man.

"—sing, my swans."

Ludmila spoke, standing before Shin. As if singing, with a smile.

"And so this is..."

Beyond the Sensory Resonance and the noisy wireless, Vika's

voice made its proclamation:

Commence operation. Now—

And Ludmila continued—with rapture and serenity, like a martyred saint looking up at the guillotine.

—sing, my swans.

“...our version of joy.”

And at that moment, all the concentrated Alkonosts charged forward. But in place of a battle cry, the girls erupted in bright laughter, like the loud rustling of flowers. As if crossing the calm fields of spring, they strode through the blemished, stained battlefield. Cutting through the horizontal bombardment of the Skorpion types from the fortress, the first row arrived at the trench.

They blew the anti-tank obstacles from the bottom of the trench with close-range bombardment, turned around, fired wire anchors into the nearby wreckage of their comrades, and swerved their frames in an odd dance, tossing themselves to the bottom of the abyss behind them.

“What...?!”

The Alkonosts’ bluish-white shadows disappeared into the valley of frozen snow as if it was all a bad joke. They dragged the charred, blackened remains along with them as they leaped over the impact marks carved into the earth and, drawing an arc through the air, dived in after them. The heavy, ominous sound of them crashing and breaking against the ground reached the Eighty-Six’s ears, reverberating against the ice walls.

Before the echoes could even disappear, the second row of Alkonosts arrived, throwing themselves in after their comrades. Then the third and the fourth rows followed without a hint of hesitation, dragging the materials they’d harvested and the wreckage of their comrades down with them one after another. Like a flock of foolish mice, rushing into the surging river at the sound of the pied piper’s flute.

The Skorpion types’ fire downed a single Alkonost unit halfway through its death march. The one right behind it pushed its wreckage forward and dived into the trench with its comrade locked in its embrace. Towing and dragging their fallen consorts, the flock of blue-white spiders jumped down, one after another,

and another after yet another. Laughing all the while, from the bottom of their hearts, with cheerful voices.

Having realized the Alkonosts' intent, the Skorpion types on the walls leaned forward, concentrating their fire on the moat. The barrage hit the front of the moat in an attempt to prevent the Alkonosts from coming any closer. The Alkonosts stopped for the first time and fired upward, gunning down the Skorpion types that had exposed themselves by leaning forward and knocking their destroyed remains into the moat. Any Alkonosts that were hit by the enemy shells were also kicked in as the Alkonosts that followed filled the hole with ruthless gunfire.

Having realized the foolishness of giving the enemy more materials to work with, the usually fearless Legion withdrew behind the walls. The Alkonosts continued dashing forward and throwing themselves to their deaths as their consorts provided covering fire. All with the madness of fanatics throwing themselves before the feet of their idol—the Juggernauts...

The moat's twenty-meter depth was soon filled up by the Alkonosts' massive several-ton frames. Their comrades rushed forward and, upon seeing that they still didn't have enough elevation, squatted down and latched onto the wall's base. The next group of Alkonosts jumped over the former's backs, reaching their legs out as the ones beneath them were crushed under their weight. Using their very bodies as building blocks, the Alkonosts assembled an upward-sloping bridge.

Once, in times past, an empire that had prided itself on its engineering techniques had constructed a siege route out of tens of thousands of prisoners and slaves to get across a two-hundred-meter wall, all to topple an impregnable fortress in the middle of the desert. And as if inspired by that tale, the Alkonosts formed a slope heading for the ramparts—a siege route formed by metallic wreckage. The Alkonosts themselves were the main components here, but they also dragged Skorpion types into their endeavor, as well as Ameise, which the Sirins themselves came out to push down.

Stepping over this bridge, the next line of Alkonosts climbed up. Crushing their consorts under their feet, only to be crushed by the units that would come after them, they gradually gained

height. The girls' laughter kept on reverberating, with the Eighty-Six only being able to watch wordlessly as the madness unfolded before their eyes.

This sight was also visible to Lena back at the command post, from her perspective above the walls.

"Vika...!"

"We couldn't have the Eighty-Six do this."

As she wheeled around to face him, the boy who'd ordered this suicidal charge didn't so much as furrow his brow. His cold, frozen eyes were locked on his dolls, which were laughing even as they were crushed.

"I can't be frugal with those girls and let my men and the Eighty-Six die in the process... Once someone dies, there's no bringing them back. They can't be replaced, not by anyone."

At that moment, Lena couldn't know the meaning behind his pursed lips. She'd never heard him speak of the mother he'd lost forever in his attempt to resurrect her, nor of the girl who served as Lerche's framework, who'd died and left him behind. However...

"But they—the Sirins—are dead. They're merely imitating humanity, technically without even personalities of their own. The Sirins are mass-produced, and they're replaceable. There's no reason to lament using them in this fashion."

He spoke, casting them aside coldly, never looking away from the sight of the dolls' breaking and shattering. He who had kept one of them, Lerche, constantly by his side... He who had given those inhuman girls human names and distinct forms.

The sight of his face as he watched them was like a knife in Lena's heart. This was the coldhearted serpent, this monster incapable of understanding human empathy, who tried to defend humankind and its world by using his own set of logic and morals.

The final Alkonost rushed forward, climbing up the manufactured incline with the sound of crackling and creaking echoing from its footsteps. Seeing it off, Vika turned around. Taking up an anti-tank rifle from one of the royal guards, he headed out of the command post, accompanied by the soldier.

"I leave the infiltration and command of what follows to you,

Queen. We'll go out on the offensive along with you. Give us the timing for attack."

He made it clear through his actions and not his words that having lost all his troops, he no longer had a role to play here.

The final Alkonost to rush out extended two of its ten legs upward to climb the wall. It was showered with fragments, and its cockpit was half blown off, but the climbing irons at the tips of its legs dug into the rock face, and it went silent after locking all its joints.

Thus, the bluish-white spiders' death march finally came to a conclusion.

The only remaining Alkonost was Chaika, Lerche's rig. The rest of the unit had quite literally thrown their lives away, forming a siege route paved by madness incarnate. Near the top of the incline was Ludmila, who had been caught in the siege route and had barely retained any of her original shape, with her neck cut through and her head dangling upside down, gazing awkwardly at Undertaker—at Shin, who sat inside it.

He could tell she was smiling. Her artificial skin and muscles contorted gracefully, even as her metallic skeleton was visible beneath what remained of the left half of her face.

Come now, everyone. By all means, her smile seemed to say.



* * *

“Tch...!”

He couldn't suppress the shiver running through his body. The others likely felt the same way. Every Juggernaut in their force hesitated for a moment, faltering at the idea of stepping onto this grotesque siege route. But as Shin stood frozen in place, the roars of the Legion reached his ears. The Skorpion and Ameise types that had retreated once because of the Alkonosts' fire were beginning to crawl out of hiding.

After everything they had just witnessed, they couldn't let the Sirins' deaths be for naught.

Shin gritted his teeth.

“—Let's go.”

“You can't be serious...!”

That was likely Rito. Ignoring the scream that came from someone else, Shin pushed his control stick forward. Following the patches of exposed black soil left behind by the Alkonosts' rush, Undertaker moved forward as the vanguard. After a moment's delay, Laughing Fox, Gunslinger, and Snow Witch followed in his footsteps. Then the remaining units of the Spearhead squadron joined the rush, swearing as they went.

Most of the Eighty-Six present had survived years on the battlefield of the Eighty-Sixth Sector. Even without being ordered to, the squadrons in charge of the rear guard opened suppressing fire. The Skorpion types that moved forward lowered their heads as the Juggernauts pressed through the curtain of snow, and the sky above them gleamed with fire.

The snow grew heavier. As if to drown out the Sirins' wails.

They reached the moat filled up with wreckage. Without reducing his speed in the slightest, Undertaker stepped onto the grotesque bridge and rushed over it in a single breath, climbing up the incline. Since it hadn't been filled by actual building materials, the road's footing was uneven, and the Juggernauts' legs got caught in it easily.

Even with their eyes fixed on the goal, they still caught sight of

the ghastly remains of Sirins paving the way forward and the way the Juggernauts' footsteps kicked them up and crushed them further. Swatting aside the ruins of self-propelled mines was almost a daily occurrence for them, and Sirins may have had human shapes, but in truth, they were no longer human. They were fundamentally no different from the Legion, which assimilated the brains of the war dead to continue the fight.

It was the same thing. It should have been the same thing. Destroying the Legion and stomping over the Sirins as they advanced...

"Tch...!"

It should have been the same, but this indescribable sense of disgust wouldn't go away. It was as appalling as running over a mountain of corpses that clung to your legs as you stepped on them, coiling around your limbs and refusing to let go.

Shin thought he could hear Theo murmuring an "I'm sorry...," Kurena moaning a pained "I hate this," and Anju trying to suppress the shiver in her voice as she attempted to soothe a weeping Rito. At the edge of his optical screen, he caught sight of Undertaker's leg stomping on the back of a Sirin that was still trying to move. Her flowery lips widened in something like a scream. Her hands spasmed toward the heavens—perhaps seeking help or perhaps simply overloading—before silently plopping down powerlessly.

The Juggernaut's system had no feedback feature. No matter what he stepped on, the buffering system would kill off the movement, allowing the Processor to feel only a slight vibration, and the Juggernaut was loaded with powerful shock absorbers to allow its high-speed maneuvering, which meant that stepping on top of a human wouldn't so much as jolt the cockpit.

And that was why the sensation in his hand gripping the control stick, of an eggshell being crushed, and the sound of stomping, which should have been drowned out by the Juggernaut's engine and footsteps, must have been illusions his mind had conjured up. And so was the bloodstain that splattered over Undertaker as he heard that scream.

Shin's teeth squeaked as he clenched them too hard.

.....No.

He just hadn't realized. Hadn't perceived it as such. He'd forgotten just where he was.

For a Name Bearer, a Personal Name was both a title and a curse, given to those who'd escaped death's clutches and returned alive from the place where so many of their comrades had lost their lives—to war demons who'd survived by drinking the blood of their companions, piling up the corpses of both friend and foe. A name reserved for a monster who'd returned alive from the Republic's Eighty-Sixth Sector, a battlefield only one in a thousand ever walked away from.

Feeling wretched now would be a lie.

Because the path he had walked up to this point—the one that had led him to the here and now—was paved over a mountain of his comrades' remains.

Surviving meant walking over someone else. Someone who was dying. Someone who was *still alive*. Someone he couldn't save, someone he had to abandon, someone he couldn't reach out to. And without even noticing, he would have to pass by someone dying, surviving as he walked over the piled-up bodies and through pools of blood.

This was no different. He pressed onward, moving forward, even if it meant stepping over a mountain of corpses. This sight simply happened to be a manifestation of that. If anything felt wretched...it wasn't just this siege route but the entirety of the path that had led them to this point... It was unavoidable, because there was no such thing as a war without casualties. There wasn't a nation in existence that had survived without sacrifices.

Man simply did not know how to survive any other way.

An unblinking, now functionless head with crimson hair flashed in his field of vision. The reverberations of Undertaker's dash shook the dangling head free from the wires in its neck, and it rolled away out of sight. A gasp escaped his throat, but he didn't allow the tears to fall.

Lena. I'm sorry. People living...humans living... I...

...I can't find beauty in that.

Unlike a palace, which exemplified authority and the height of comfort, ramparts were made for battle. Their very structures were both sword and shield against invaders. The towering walls and the dry and flooded moats that surrounded them were a given, but the machicolation was set at the upper part of the gates, the partitions got higher and higher the deeper one went, and the castle keep had its entrance set only on its second floor. Clockwise spiral staircases. Those had all been viable mechanisms in the ages when swords and bows had been primary weapons, and they still showed their value.

The interior of the citadel sat at the square opposite the southern palisade. Lying in wait just below the very top of the wall was a group of Skorpion types aligning the sights of their howitzers in anticipation of an enemy attack. They couldn't stop the siege route's construction, but they could still prevent infiltration by attacking the moment the enemy would be defenseless as they tried to charge in.

The siege route was a rush job and built very narrowly. It was complete folly on a strategic level, since the enemy forces still had to divide themselves, and many enemy Feldreiß had been sacrificed to form this route, meaning their numbers had effectively been cut in half. They wouldn't be able to maintain this do-or-die charge for long.

It was then that metal anchors zoomed past the serrated arrow slits, flying toward the top of the walls. Two of them. Four lines with a talon at each end—a wire anchor stabbed deeply into the top of the palisade, fixing itself in. In the next moment, two Juggernauts flew in from both sides of the Skorpion types' sights, shooting up over the top of the walls overlooking the Long-Range Gunners.

Their Personal Marks were of a laughing fox and a headless skeleton bearing a shovel.

“—What are you, morons?! Of course you'd be aiming for us, so what idiot would rush in from the front?”

“It dawned on me when Dustin said it. Former Republic citizens

wouldn't know anything about infiltration theory."

Theo spat out his comment, as if he'd shaken off the agony they'd experienced just a moment ago—and Shin finished his sentence, with the coldness of having shaken off too much of that agony. Two blasts were fired at the same time. Their 88 mm tank turrets roared, their lines of fire of an initial velocity of 1,600 meters per second piercing into the Skorpion types' flanks. The multipurpose projectiles burst upon impact, unleashing a flood of metal jet and a flurry of fragments that ruthlessly burned down the Skorpion types' unarmored hides.

Of course, the Skorpion types didn't passively receive the attack. Their optical and gun-sight sensors fixed their lasers on the two targets, and they attempted to turn their bearings against them in accordance with their tactical algorithm.

Attempted...and failed.

As they tried to change their bearings, the other Skorpion types' barrels got in their way. One of the Skorpion types banged against another and staggered, blocking both of them from moving. The Skorpion types were cramped in the confined inner hull of the palisade, standing stock-still and unable to move. The Juggernauts emptied their cartridges in the blink of an eye, aiming at their flanks in a ruthless barrage.

The palisades were structured to separate and impede an invading enemy force, segregated into cramped, confined sections by partitions, and that applied to the dull Skorpion types and the long barrels on their backs. The Skorpion types, which lacked revolving turrets, could attack only what was in front of them. And now that they were unable to either counterattack or evade, they were sitting ducks.

Other Juggernauts zoomed in diagonally with their wire anchors, following the path of the two vanguards, and joined in the assault. They used machine-gun fire to scatter the self-propelled mines that covered the walls to stop any invaders, then employed their turrets to mow down the Ameise that rushed in.

A single unit—Dustin's Sagittarius—left the warped wreckage of the Skorpion types and used its smoke discharger to form a white smoke screen, hiding the movements of the invading force. Under the cover of the smoke screen, the Claymore squadron, led by

Rito, rushed to take over the hangars as the doors of the surface suppression units' missile pads opened.

"—All launcher units. Suppress all transferred coordinates!"

The launcher units fired under Lena's orders. The missiles sailed into the air above the surface sector, leaving trails of white smoke in their wake before unleashing the cluster bombs within, which rained over the sector and onto the lightweight Legion that rushed toward the Juggernauts. The anti-light-armor self-forging fragments triggered, forming a shower of flames that traveled at three thousand meters per second and sweeping down the lightweights with a deafening sound.

The upper part of the citadel was thus suppressed. All that remained was to sweep out the remnants of the enemy. Chaika stopped at Undertaker's side. Its rear canopy opened, and Lerche showed her face, shouting:

"Sir Reaper, now, while we have the chance!"

"Right."

Their 88 mm cannon was out of ammunition. Laughing Fox had machine guns equipped on its sub-arms, so that wasn't as much of a problem for it; Undertaker, however, was equipped with melee armaments, putting it at a disadvantage should a firefight break out.

At that moment, an unnatural wailing rang out.

It was a ghostly wail only Shin could hear. A lamenting voice, weaving a mechanical language he couldn't understand. The sound of a purely mechanical intellect that shouldn't exist now that the limit of six years since the Empire's fall had passed.

The battlefield was still thick with white smoke, making it hard for the Juggernauts to detect one another's presence. But Shin's ability persisted through the tumult of the battlefield, accurately detecting the source of the wail. The citadel's rock canopy soared above like an eagle spreading its wings to defend its chick. In between those great wings, a figure stood composedly among the remains of the eagle's skull, which had been struck down in a past war.

The nimble silhouette of a savage predator. A sensor unit resembling a lion's head and a chain blade on its back, so delicate that the individual segments looked like flight feathers. Shin could

almost make out the glint emanating from its pair of glaring optical sensors through the white smoke.

The Phönix.

THE CAUTION DRONES

High-Mobility Type

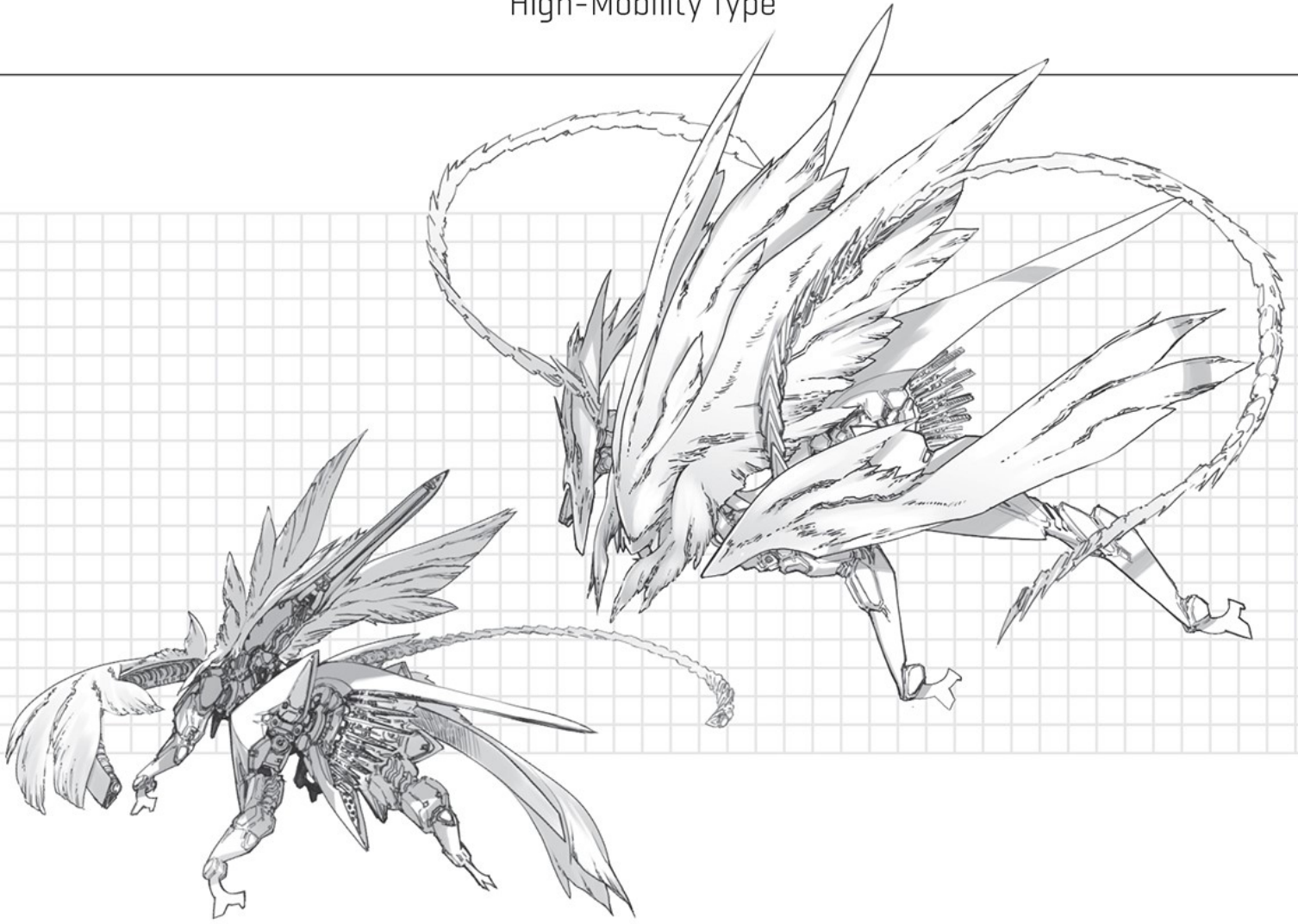

Phönix (Variant)

[ARMAMENTS]

Special mobile-type High-Frequency Blade [x2]

Liquid Armor [properties unknown]

[SPECS]

Total Length: approximately 2.6 m / Head: approximately 2.1 m

Weight: unknown

Special Note: This variant is clad in something resembling a liquid metal but is still lightweight. This liquid-metal defense makes up for the vulnerability stemming from the Phönix's design for high-speed combat by serving as supplemental armor, augmenting its defense against bullets and fragments. In addition, it retains its ability to enter stealth mode by cloaking itself with optical camouflage using the Eintagsfliege.

The new jet-black Legion type encountered in the Republic's underground railway terminal, capable of cornering even Shin, appears once again in a reinforced form. Its unique liquid armor is presumed to have been added to augment its defenses following the results of its previous skirmish.

It retains its agile movements, stealth, and two menacing high-frequency chain blades.

Although it should be noted that Shin's party was absent and the Phönix slipped in just as Raiden's delayed party left, it was capable of single-handedly toppling an entire base, standing as proof of the overwhelming threat it poses.

* * *

A single, barely functioning exterior camera projected the image of the Phönix to the command post's holo-screen. Lena narrowed her eyes as she looked at it.

Its appearance...

Frederica seemed to have the same thought as she furrowed her brow.

"...It looks different from our data. What are those extravagant wings?"

Wings. Yes, *wings*.

Its nimble, four-legged fuselage, reminiscent of a lion's or a leopard's savage visage, was disturbed by knifelike wings with a silver veneer. In between them, at the part that corresponded with an animal's scapula, a pair of long chain blades extended, giving the Phönix the chilling image of a griffin soaring through the heavens.

Each of its wings vibrated with movements unlike a living creature's. It gave off a delicate glow that contrasted with the snow and bewitched all who laid eyes on it. It was a metallic silver glow that flowed like liquid.

"Liquid armor...?!"

According to the report Shin had submitted, the Phönix had even less armor than the Ameise. Because of how thinly armored it was, once a section of its armor was removed by HEATs, it could be penetrated with measly antipersonnel 7.62 mm rifle rounds. Without that weakness, Shin likely wouldn't have been able to shoot it down.

In fact, just seeing its mobility on the mission recorder rendered Lena, who wasn't even on the front lines, speechless. It had such blinding mobility and combat speed that it made even the other Legion, which had already transcended humanity's base limitations, pale in comparison. And in that one battle, it had realized and conquered its weakness. Or perhaps it had simply still been under development the last time Shin had faced it.

However...

Lena pursed her lips.

The fighting in each of the corridors against the onrushing Legion was growing fiercer, and an invasion path from outside the castle was being formed. If the Legion lost control of the surface to the Juggernauts, the underground section would be attacked next. Realizing they would have to take over the citadel before that happened, the Ameise and self-propelled mines repeated their suicidal rushes.

Exposed to the fire of a Skorpion that forcibly sneaked in, the fifth corridor's final bulkhead partition collapsed. In the midst of hectic battle, a wireless message from another squadron reached Raiden's ears.

"—Vice Cap'n Shuga!"

"Rito?! Where are you right now?"

"We should be right in front of you in around sixty seconds! We'll be charging in, so make sure to avoid us!"

"Tch, all units, cease fire and retreat from the front of the elevators! Escape the line of fire!"

Soon after the Juggernauts and Barushka Matushkas all almost forcibly jumped away, 12.7 mm machine-gun fire rushed the back of the Legion's lines. The barrage was fired in a total surprise attack from the elevator shafts leading to the complex path back to the surface. The Ameise were shot through their thinly armored backs, and the self-propelled mines were scattered. Stepping over their crushed remains, Rito and the Claymore squadron infiltrated the underground sector, attacking the remaining Legion that had avoided their attack.

"We've got the surface sector under control, and we have friendlies taking over the other corridors. You get to the surface, Vice Cap'n Shuga!"

"Right..."

Raiden broke off and furrowed his brow. This uncharacteristically reckless entry and the overly violent machine-gun fire felt like an extremely desperate charge when coupled with Rito's nervous scream through the Resonance. A few Barushka Matushkas that failed to get away in time were hit by stray bullets and were fine only because their thick front armor

was able to deflect machine-gun fire.

"...What's wrong, Rito?"

"It's nothing!"

There was something scathing in his response. Like if he wouldn't have said that, he'd have broken into tears right away. As if he'd just lost many of his comrades and thought he saw his own corpse littered among the piles of their bodies.

"It's really nothing... So please just hurry."

The white smoke cleared. The Phönix lorded over the garden of battle as the gauzelike curtain of snow grew fainter. As it loomed over the canopy, like a bird with spread wings, the battlefield below it was surrounded with several observation spires set in a counterclockwise formation. The metallic remains of destroyed Skorpion types littered the ground along the inner hulls of the palisades and internal partitions, which had crumbled from a barrage of tank shells.

The all-too-gruesome marks of battle that permeated the silent white. The unsightly signs of strife and the serene impermanence. The Phönix looked over it all equally. And it confirmed Undertaker's position at the deepest part of the Juggernaut formation, still standing behind the southeastern partition, with sight alone.

Returning its gaze, Shin addressed all present.

"All units, spread out. Avoid close contact with it at all costs. You'll get hit by stray bullets."

It inclined its beast-like head forward, its limbs bending and building up strength.

It's coming.

It leaped into the air, falling straight down and brandishing its chain blades to control its altitude. Landing on one of the spires' roof tiles, it used the impact to build up momentum and kick itself forward. Toward Undertaker.

Chaika jumped out of the way, gaining distance so as not to get in the way of the battle. Abandoning its empty magazines, Undertaker braced itself. As it did, the Phönix jumped from spire to partition, kicking against their surfaces with blinding speed,

closing the distance in the blink of an eye. The pieces of concrete and ice scattering into the air were the only way to track its movement by sight. Its silver shadow swooped on Undertaker, intermingling irregular hops to the left and right into its stride...

When...?

"Right on the money. You have to be a special kind of idiot to rush in like that."

A cannon shell appeared by its flank. It was close-range bombardment, traveling faster than the speed of sound. The shooter was a Juggernaut hiding in the shadow of the spire. Kurena's Gunslinger. Even if she did predict its trajectory, it still traveled at a speed unimaginable for a land weapon. She had discarded the weapon-control system's support to begin with, achieving the miraculous feat of sniping it down based on intuition alone.

The shell traveled faster than the sound it left in its wake could, rushing forward with no sight laser, but the Phönix discerned it just by the muzzle flash. It canceled its jump by braking, just barely evading the round.

However.

The round, which should have missed its target as it got out of its trajectory, burst in midair, flashing and self-destructing right in front of the Phönix. Flames and shock waves burst in all directions at a speed of eight thousand meters per second. The fragments launched by them traveled at a speed faster than even the Phönix could dodge.

A proximity fuse. Originally a special fuse intended for anti-aircraft use, it was set to burst and release fragments even without impact in the event that it entered the electromagnetic field of the target. Unable to evade several of the fragments, the Phönix was knocked down to the ground. Apparently, they hadn't penetrated its armor, but some of the liquid covering it was torn off and took to the air like flower petals.

"—Why, hello there, you stupid little thing."

Lying in wait near its predicted landing point, Snow Witch—or rather, Anju within—smirked ruthlessly. The next moment, the missile launcher at Snow Witch's back opened and fired. The missile zipped through the air in different zigzagging trajectories,

rushing toward the Phönix and pouring a shower of smaller bombs, which peppered all possible escape routes—including the one the Phönix chose—with a time lag.

The Phönix tried to escape the barrage, but after concluding that it couldn't, it forcefully pushed on and fled into the air.

“—Ha, here it comes. They do say only idiots and, uh, something else like high places.”

Laughing Fox lay in wait, having fired its wire anchor into the slanted roof tile of one of the spires, and turned the heavy machine guns in both of its grappling arms toward the Phönix. Theo pulled the trigger. The Phönix was in the air, where it couldn't move normally, and had to take the first few bullets directly. It then swung its chain blade in a wide arc, driving it into a wall as an impromptu anchor and constricting it to zoom away forcibly and escape the barrage's strike zone.

Laughing Fox promptly abandoned its firing position and flew toward another spire with its wire anchor in an attempt to pursue it, when a new Juggernaut began sniping it. Another area suppression by way of small bombs. Machine-gun fire from Wehrwolf, who hurried over from the hangars.

“—Feels like we're hunting some big game here. Wouldn't wanna be this thing right now.”

As the Phönix tried to evade the attacks by jumping onto the breastworks, several shots of accurate small-caliber fire to its foothold sent it tumbling down. As the Phönix fell over, the bullet marks remained carved into the rock face. They came not from the Juggernauts' 88 mm cannons nor the Barushka Matushkas' 120 mm cannons, but from mere 20 mm anti-tank rifles... Several people fired at it, one of them being His Majesty the prince himself.

Finally shaking off the barrage of armor-piercing rounds aiming for its flank, the Phönix landed and looked around at its surroundings. The Legion were combat machines, and this one in particular was a pure mechanical intelligence, so it likely didn't have anything in the way of human emotions. But if it did, now would be the moment when it clicked its tongue in annoyance.

They were everywhere. On top of the walls, over the bulkheads separating them into sectors, and sitting atop the

observation spires. In the shadows of the oddly arrayed facilities and their interiors. All of them avoided the others' line of fire, but the Phönix was in the center. The multiple white silhouettes of the Juggernauts blended into the snow as they encircled it.

Overlooking the situation from the holo-screen, Lena whispered coldly.

"It's definitely fast, and its mobility is astounding... But that doesn't mean there's no way of dealing with it."

Its speed, which rendered all fire-control systems useless, was unmatched for a land weapon, without a doubt. But there were modern weapons capable of shooting down even fighter jets, which had moved at even more blinding speeds in the days before the war with the Legion had sealed off the skies.

One such weapon was the proximity fuse, which triggered when approaching an enemy even if it didn't impact it, then unleashed a buckshot of molten fragments. Or cluster warheads, which unleashed a shower of small bombs that covered a wide radius at once. Or machine guns and autocannons, which unleashed dozens of bullets per second with their firing cycle, forming a thick barrage.

If their sights couldn't keep up with it... If aiming and firing at a single point proved impossible...

"We just need to strike over a large area... That's all there is to it."

They had already established this countermeasure, in terms of both tactics and the weapons they'd need to use. The only reasons Shin had struggled so much against the Phönix the first time was because he'd never encountered anything like it before and, in a manner of speaking, because of his own nature as a warrior. Undertaker was a unit that specialized in melee combat and lacked any wide-area weapons. It would be hard for him to mount an effective counterattack on his own.

"I had been wondering how you would lure it into the barrage, but never would I have expected you to use Undertaker as bait," remarked Frederica. "The blood running through your veins is colder than I thought, Vladilena."

“The enemy’s objective is both annihilating us and capturing Shin. There’s no way we can know that and not take advantage of that fact.”

The Phönix’s greatest failure was letting Shin escape during their last battle and bring back a report rich with valuable information—like an account and estimate of its specs...and its goals. It hadn’t killed Shin when it was perfectly capable of doing so, and this suspicious sequence of actions made their objective perfectly clear.

Since they knew what it was after, they could lure it in with bait. From their perspective, the Phönix was a foolish, starved wolf they lured into their encircling net by dangling its desired prey before its eyes. Yes, the Phönix had once single-handedly overwhelmed a full squadron of Reginleifs and destroyed them all without taking a single hit. It likely judged that the gap between its combat ability and the Reginleifs’ was considerable.

And based on this estimate, the Phönix wouldn’t pay any mind to anything but its high-priority target, Shin, focusing all its attacks on him. So they would use their consort units as bait to lure it into a wrong decision and overwhelm it with sheer numbers.

It was an utterly cowardly tactic. She’d thought they might dislike it, but once she proposed it as a countermeasure after the terminal operation, the Eighty-Six, Shin included, were rather indifferent to the idea.

The Eighty-Six’s fundamental strategy was based on engaging a single Legion with multiple units to begin with. They had no choice but to rely on traps, lures, and one-versus-many tactics if they were to defeat those unreasonable, high-fidelity steel monstrosities in a faulty aluminum coffin of a machine. They wouldn’t see this tactic as a cowardly one.

“Aide Rosenfort. Captain Nouzen is currently in charge of perceiving the enemy unit’s position, and Second Lieutenant Iida will be joining the battle as soon as she’s done clearing out the facility. Both are combat personnel, though. We’ll be relying on you when the two of them aren’t free to issue warnings.”

Frederica scoffed adorably.

“I told you to call me Frederica, you dolt... Understood. I will

handle this.”

The Juggernauts had already placed their traps throughout the surface sector. On top of the walls and the partitions, on the peaks of the spires, between the labyrinth of bulkheads and buildings. They surrounded the Phönix from all four directions and above. The Phönix zipped around, trying to evade and break through the encirclement, but wherever it appeared, it was ambushed, leaving a silver spray in its wake.

Buckshots rang. Small bombs rained down. Machine guns roared like beasts, and anti-tank rifle rounds tore through the cold air as they flew toward it. To top it off, while the mobile weapons engaged one another, soldiers ran out and set up new directional buckshot mines, which unleashed a fanlike spray of steel balls that stormed into the Phönix.

Big-game hunting.

No name could have been more fitting for this battle, Lena thought as she looked over the goings-on through the optical screen. Such a ferocious, cunning, dangerous animal was far stronger than any human, but they were hunting it down by pooling their intellect along with their weapons. Such was the nature of this battle.

“Falchion squadron and Glaive squadron, shift positions to the southern third block. Captain Nouzen and Second Lieutenant Iida, use Undertaker to lure it into said block... Enemy remnants detected in corridor twenty-three. Mace squadron, deploy to clean them up.”

“Roger.”

Sweeping up the enemy remnants in the underground sector and hunting the beast on the surface. As Lena moved the pieces on those two battlefields at the same time, the light running through the Cicada shone in dizzying patterns. The beams of light signifying it was operating at high efficiency illuminated the darkened command post.

As it evaded attacks, the Phönix raised its beast-like head as if calling for something. The clouds above grew thinner as a flock of Eintagsfliege fluttered down, and the Phönix dived into it,

wrapping itself up in them from top to bottom. The optical camouflage deployed, hiding its silvery silhouette from sight. Its invisible legs kicked the ground in a thumping sound, leaving only the cracked floor under it as its final footprint as it disappeared somewhere—

“—Michihi, in five seconds, straight ahead... Fire!”

“Yes, sir!”

Abiding by the instructions given by Shin, who was capable of perceiving the enemy’s position regardless of the laws of physics, a platoon of six units responded immediately. They all unleashed a barrage of machine-gun fire that tore off the Eintagsfliege’s camouflage and rendered the Phönix visible again, and it dived into cover, evading the line of fire that pursued it. The thick concrete pillar got in their way, and the Juggernauts’ weak sensors lost track of its position.

“Too easy! Crow, give it a good serving of bullet fillet!”

“Understood, Iida, but contain yourself.”

Shiden, who had left sweeping up the enemy remnants in the hangars to the command post’s guard unit and risen to the surface to assist with recon, cackled indomitably.

“The way you give target direction like that Li’l Reaper makes my skin crawl, though... C’mon, squirt, where’s the next one?!”

“Do not call me squirt, you insolent oaf! It’s the southern fifth sector, central passage, fire!” shouted Frederica, her crimson eyes glowing softly. The small missiles soared, leaving trails of white smoke as their seekers activated, charging toward the Phönix. Infantry units hidden on the roofs of the facilities rose up, shouldering heavy surface-to-air missile launchers and firing at their opponent.

The Phönix made a large horizontal leap in an attempt to avoid them, but the missiles took a sharp turn and tracked them accurately. Active homing. Metallic bullets that relentlessly pursued any target that had been exposed to their homing lasers like cursed ammunition, until they ran out of propellant or made contact.

Braking with its back to a partition, the Phönix faced the missiles head-on. The nearby Juggernauts realized its intent and retreated. The chain blades that served as its mane roared to life.

It used its pair of revolving blades to cut down one line of missiles and jumped up just as the second was upon it. The sudden movement made the missiles either lose track of the Phönix or simply not able to change trajectory in time, and they all crashed into the partition and burst.

The thick reinforced concrete partition collapsed with a rumble. Blending into the dust and smoke, the Phönix kicked against the walls from left to right, heading up to the canopy—

“Activate!”

As that sharp order was called out, electric wires were fired off horizontally from each of the spires, forming an impromptu net in midair that knocked the Phönix down midjump.

_____?!

Knocked down against the flagstones, the Phönix rose to its feet at once and jumped away in a blatant reaction of surprise. It had likely never imagined they had this kind of ridiculous trap in store. Vika, who was the only one who'd react with amusement to the situation, spoke through the Resonance.

“This is a trap we set up to capture helicopters in the event that the citadel came under siege by an aerial raid, in a ‘let us die with the Philistines’ sort of fashion... Heh, my ancestors had quite the nasty disposition, if I do say so myself.”

Raiden asked with an exasperated voice, **“I’m almost afraid to ask, but you didn’t put any self-destruct bombs in your base, did you, Prince?”**

“Mm? I most certainly did. It’s only natural. Don’t you think there’s a certain aesthetic to blowing a fallen castle away along with the enemy?”

“.....”

Frederica likely didn’t imagine Marcel rising to his feet for a moment out of fright at the edge of her vision.

She then whispered, “I am beginning to suspect that he...or rather, the Idinarohk Espers as a whole, are simply fools playing at intelligence...”

Lena couldn’t help but feel the same way.

...Well, anyway.

“Fifth sector’s second bulkhead partition breached. All Juggernauts in said sector are to move to the adjacent fourth and sixth sectors. Skyhawk squadron, please head to assist. Lycaon

squadron, you're almost out of ammo, correct? Change places with the Scythe squadron."

A pop-up message appeared in one of the sub-windows. The front gate's blockade was removed, and the Scavengers began entering the base... The siege route aside, Fido and its group couldn't climb up the vertical walls, so they'd had to go around and come up through the frontal road and just arrived.

"We go in and mow them down. Don't give the enemy a moment to rest."

"...No."

Contrary to Lena's zeal, Shin squinted bitterly. The Phönix's liquid armor proved tougher than expected. As it was able to change its shape freely, it could alternate between acting as spaced armor capable of stopping HEAT projectiles and acting as restraining armor against APFSDS rounds. The standoff distance from the point of explosion diffused the metal jet, and any depleted uranium rounds that did hit it had their bullets crushed within the armor. The liquid also had dilatant traits that made it momentarily harden upon impact, so even as it spurting out in silvery flashes upon being hit with buckshot and anti-tank rifle rounds, the armor did block their penetration.

While the majority of the liquid armor had been scraped away by the fighting so far, the damage to the unit itself was light. On the other hand, some of the Juggernaut units were already beginning to drop off from the fighting. Laughing Fox was forced to retreat, having depleted the ammo of both its 88 mm cannons and its two heavy machine guns. Gunslinger took a wrong turn, allowed the enemy to get too close, and crashed down after having its legs severed. Snow Witch had to purge its empty launcher pad and was being towed away.

Five of the anti-tank rifle turrets had already been destroyed, and the infantry had to retreat after depleting the ammo of their carried weapons. And lastly, the spires and bulkhead partitions were being destroyed one after another as well. The encirclement net was coming undone. Fido and its group of Scavengers arrived, but it would take time to regroup and restock, and they had to

maintain their current fighting power somehow until that happened...

The Phönix suddenly stopped in the center of a corner where the facilities were mostly crumbled to dust from the bombardment. It turned its head like an animal, confirming the positions of the Juggernauts surrounding it. Several layers of the feather-like armor covering its body suddenly melted, reforming into the shape of a thin, coiling cylinder. A gun barrel. And an extremely thin and long one at that—its initial velocity would be extremely fast!

“—It’s gonna shoot! Dodge it!”

In the blink of an eye, silver threads spread out in all directions, with the Phönix at their center. That was likely another transformation of the armor. The projectile that formed was a large, sharp fléchette. Its firing mechanism was either pneumatic—based on condensed air—or centrifugal; they’d foolishly believed that since the Phönix couldn’t carry heavy weaponry, it wasn’t capable of ranged attacks.

The fléchette didn’t seem to have the penetrating power to pierce through the Reginleif’s light armor, but it was still a heavy sphere moving at an incredibly high velocity, and a single shot that depleted most of the liquid armor. The Juggernaut that took a direct hit staggered heavily and stopped in its tracks. In a single bound, the Phönix rushed through the gap it had made in the Juggernauts’ formation.

Its silver sights closed in on the silhouette of Cyclops, which was situated in one corner of the breached encirclement net. The Phönix brandished its left chain blade diagonally, slicing through Cyclops as it passed the Juggernaut by.

“Kch, you little!”

Cyclops fired back as Shiden clicked her tongue in annoyance. Since she couldn’t evade it, she instinctively decided to make it avoid her instead. As she intended, the Phönix moved its trajectory away from her line of fire, shifting off the course that would have let it sever Cyclops in half as a result. A moment later, a warhead cut into eight pieces made contact with the Phönix’s back just as it pulled its barrel back, only to fall apart and detonate.

The HESH (high-explosive squash head) projectile's shock waves were transmitted into the Phönix's liquid armor, scattering it violently. But at the same time, Cyclops was cut down from its right machine gun to its rear and front legs and forced to fall over and run aground.

"Shiden!"

"I'm fine... Forget that."

Shin could hear Shiden gritting her teeth when the proximity alert blared through his cockpit.

"Sorry, it got through... It's coming your way, Lady-Killer!"

"It got us...! Shin!"

Lena turned pale as she saw it happen. It broke through the blockade. That was within the realm of predicted possibility. Serving as the Phönix's bait, Undertaker couldn't retreat from the battlefield even when it was out of ammo. On the contrary, in order to predict the Phönix's trajectory better, they had to surround it in such a way that it would always see Undertaker's position...and they were well aware of the risks that entailed.

It had transcendental mobility and was armed for melee combat. They both had the same characteristics, but the Phönix outclassed Undertaker in both, making the former the natural enemy of the latter. The fact that Shin had returned alive from their last encounter was nothing short of a miracle.

But this time...

The Phönix rushed forward, brandishing its chain blades. Undertaker shifted two of its legs to the left, bracing half of its body for impact.

They clashed.

Undertaker's high-frequency blade cut through the Phönix's armor from the left...

...and the Phönix's chain blade, as if cutting through water, sank into Undertaker's cockpit.



<<Rejecting recovery of target. Barog eliminated.>>

<<Destruction of inner armor confirmed. Absence of organic reaction confirmed.

Confirming-->>



Lerche's lips curled into a twisted smile *from within Undertaker's ruined cockpit.*

"You missed, you piece of scrap metal."

"It can only tell us apart by our exteriors, huh? Our armaments and Personal Marks."

At that very same moment, Shin whispered *from inside the cockpit of Chaika*, which sat crouched behind the Phönix. He'd switched places with Lerche, moving from Undertaker, which had run out of ammo, to Chaika just after they'd retaken the surface sector, under the cover of the smoke screen set up by Dustin's smoke discharger.

In the face of the Phönix's speed, which allowed it to move across his field of vision faster than he could keep up with it, Shin couldn't afford to wait for Fido to arrive and restock him with ammo.

The source of that idea was something Lena suggested and Vika later ordered; Juggernauts and Alkonosts were weapons from different countries, but both were Feldreß from the same generation, intended to be piloted by humans or humanoids. In terms of their necessary functions and the ergonomic rationality behind them, their switches and gauges were all more or less similar. As such, piloting one instead of the other wasn't something that couldn't be mastered after a few switchover training sessions.

Shin's sights settled on the Phönix for the first time, and an electronic *beep* signaled that they were locked onto its target. Shin pulled the trigger, which was located on the right control stick's index-finger position—the one position that never changed in any weapon system.

It was a strike from behind, at point-blank, and a complete surprise attack. To top it off, the Phönix's left chain blade was lodged into Undertaker, rendering it incapable of moving. Even still, the combat machine's instincts prompted it to purge its left chain blade. It turned most of its armor into a wire form, stabbing it into the ground to reel its body away. In a movement that was just slightly faster than jumping or ducking away, it shifted its central processor away from the line of fire.

A moment later, the HEAT brushed uselessly along the side of the Phönix's armor. Its kinetic energy shaved off the last remains of the liquid armor and the black armor underneath it.

"...Tch."

His attack should have been a guaranteed hit, yet it still avoided the full impact. Shin couldn't help but click his tongue at the Phönix's absurd reaction speed. Never in his seven years of combat experience had he missed from this range. But now...

"So you've finally shed away all your armor, fool."

Undertaker's canopy flew open. An explosive bolt triggered, forcing it open, and from below the blown-away canopy, Lerche jumped out like a bullet. Her right leg was missing in its entirety, a Sirin's bright-blue blood oozing from it, apparently having been grazed by the chain blade. She clung to the Juggernaut's ivory armor with her remaining leg and arms, crouching like an animal before springing her body forward.

She held her saber's scabbard in her mouth and the sword itself in her right hand, having pulled one out of the other like a lion tearing the flesh off its prey with a large shake of its head. The brightness of the snow reflected off the blade, which then screeched out with a shrill voice and began heating up.

A high-frequency blade. Originally made for Feldreß use, it wasn't a weapon made to ever be used in actual hand-to-hand combat. The artificial skin of Lerche's hands was torn to bits in a split second.

"—Haaah!"

A silver comet fell over the Phönix, which intercepted it with a swing of its chain blades. The sight of a young girl—albeit an artificial one—facing off against a Legion in melee combat was one that bordered on a bad joke or a living nightmare.

The chain blade mowed into Lerche, cutting her from the waist down. Thrusting her own blade in an underhand grip, she drove it into the base of the chain blade, peeling off the Phönix's armor and lodging it into its frame. The pale-bluish light of the resulting overcurrent ran through the chain blade. Serpents of electricity ran through the saber, charring Lerche's right arm black.

Meanwhile, the Phönix staggered as the damage crept into its interior mechanisms for the first time. Lerche limply eased her grip and fell, crashing against her opponent's shoulder. The discarded scabbard of her sword finally hit the ground, clambering in a shrill noise.

The heavy sound of Chaika's gun mount sealing, which heralded its launcher reloading, resonated through the cockpit. The sound of the reticle and the alarm alerted Shin, informing him that they were locked onto the target.

Meanwhile, the Phönix purged its destroyed chain blade. The ruptured surface seeped with silver fluid. It had lost all its weapons and taken heavy damage. Enough to deem this situation suitable for abandoning its unit, it seemed. But before it could, Shin's eyes met Lerche's.

Green eyes. Even though he'd been told she wasn't human, even with the moans of the dead always coiled around her, her eyes burned with as much will and emotion as any human being's. Her lips moved, and over the Resonance, the boy who was her master shouted sharply.

"—Shoot it!"

Would Shin have refrained from shooting had either of them begged him to stop? This single doubt crossed his mind, but his thoughts ventured no further. Shin's body and consciousness, optimized for battle, almost automatically pulled the trigger.

The unleashed armor-piercing round tore the right arm from her shoulder, dropping it to the ground. The HEAT shell impacted and burst, generating metal jet that bore into the Phönix's armor, spilling into its frame from the ruptured section and setting it

aflame. A moment later, the flock of silver butterflies soared past the black flames, escaping into the snowy sky.

“So it still got away. My word, the Legion really made an irritating one this time...”

Looking up into the gray sky, Vika sighed as he shouldered his heavy anti-tank rifle. He was in one of the observation towers connected to the base’s surface facilities. If he had to guess, each individual butterfly was a system module. Even if a few of them were to be destroyed during their escape, replacements could be reproduced later. But that wasn’t the issue...

“Why would the Legion make something like this?”

True enough, the Phönix was powerful, but in terms of combat efficiency, it was significantly inferior to the mass-produced units so far. Compared to a single hero who slew many soldiers with sword in hand, several thousand who drew their bows and slew tens of thousands outside that sword’s range were far easier to produce. Such was the progress of weaponry. Ever more safely, ever more swiftly, and claiming ever more victims.

Efficient systematic slaughter.

And that held all the more true in the modern age, when a single cannon could demolish a base housing thousands, and a single tank’s treads could run over countless infantry. There was no longer a place on the battlefield for sword-toting heroes. And while the idea of a hero may have held some viability for humankind, it held absolutely no such value for the Legion.

By now, heroes were a tactic employed by the weak. By those who couldn’t match the enemy head-on, instead choosing to deliver concentrated blows that would prevent them from fighting any longer. The Eighty-Sixth Strike Package was, in essence, that kind of unit, and the eastern front’s headless Reaper was that kind of soldier.

Those who were the strongest and most battle hardened, thus the fewest in number. A powerful, thus precious and rare, silver bullet. That was humankind’s last resort, but not a tactic the Legion should have ever needed to adopt.

And there was the matter of a weapon’s other, more defining

characteristic: its immortality. If the Legion's intent was to preserve combat records, they only needed to transfer the data, as they likely had so far. If they were to maintain a backup and mass-produce multiple replacement units, a single individual unit would be disposable, and there wouldn't be any need to preserve it so zealously.

Self-preservation instincts were the most unnecessary addition one could give a weapon. And so Vika couldn't understand the idea behind the development of this weapon. It felt utterly incompatible with the Legion's essential modus operandi of eliminating all hostile elements. Although autonomous machines did at times make judgments no one could have anticipated...

It was then that the butterflies changed their course overhead.

"...Mm?"

The Liquid Micromachine butterflies circled the skies above the fortress for a moment before changing their bearing to the south, where the Legion's territories were, gradually lowering their altitude as they swooped down.

They landed surprisingly close. At a position a mere few kilometers away from the citadel.

"..."

Squinting cautiously, he called up a holo-screen with a wave of his hand. Thankfully, there was an external camera yet unbroken aiming at that area. The camera zoomed in, pursuing the Phönix, which was still within its effective range...

And when he saw it, he gasped.

Having somehow beaten back the Phönix and all the other Legion units, the command post gradually calmed down.

"...Milizé. What is that?"

Frederica's voice, tinged with urgency, echoed through the room.

"Southern external camera number five... What is going on over there?"

Her bloodred eyes were fixed on the camera feed projected onto a corner of the main screen. Following her gaze, Lena magnified the feed so it took up the entirety of the main screen.

Lena's breath caught in her throat.

At that same moment, Shin turned around, feeling an intense gaze on him. The palisades were blown off from three days of fighting, forming a gap that allowed him to overlook the snowfield spreading ahead. A few kilometers away, atop the pure, unblemished virgin snow, stood a single Ameise, its armor so old and aged that it was noticeable from a distance.

The Legion were usually rendered in a reddish-black coating, but that single Scout type was as white as moonlight, as if blending in with the snow around it. It lacked the two all-purpose machine guns, standing essentially defenseless in the deserted battlefield.

But somehow, it seemed silently overbearing. Tattered and ragged as it was, it lorded over all in a transcendent manner, like a queen standing over the battlefield.

That was the commander unit of the Legion forces the United Kingdom faced. In the shell of an Ameise—an unseen unit for a Shepherd—of the original production line of Legion, which should not have existed to this day.

The Merciless Queen.

The flock of butterflies that made up the Phönix's core fluttered down beside it, swirling as it landed. A force of Dinosauria were hiding in the vicinity, lying in wait in the snow, a veritable queen's guard.

Shin's eyes were drawn to a spot of vibrant color upon the Ameise's left shoulder. The symbol of a goddess reclining against the crescent moon. A Personal Mark. But he'd never seen a Legion unit branded with one of those...

He could hear Vika, who was apparently seeing the same Ameise, groan through the Resonance.

"Zelene...!"

Zelene was a name derived from the moon goddess of old—Selene. Perhaps the Personal Mark of the crescent moon was derived from that, or perhaps she'd simply carried that motif out of affection when she was alive.

The Merciless Queen finally turned its composite sensor in their direction. The reverberating moans grew louder. A young woman's voice, speaking the final thoughts she'd had prior to her death. A voice that, indeed, fit the woman bearing the name of the goddess of the moon. Cold, dignified, and most of all, merciless.

But despite that...

"I've...been a good girl."

It was like the voice of an infant, just barely holding back tears... A frail, forlorn voice.

"That's why I...wanted you to come back to me."

...Shin.

His mother smiled within his memory.

They were standing before the door to the church at the corner of the internment camp. Her long locks were the same red color as his brother's, and her eyes were the same crimson gemstone color as his. She was clad in a boorish, worn-out field uniform, which didn't fit her delicate demeanor. Her pale hand, which he couldn't recall ever having hit him, not even once, brushed through his hair.

Do as your brother and the reverend say.

Be a good boy...Shin.

So she had said and smiled. Her eyes gentle.

He remembered. He remembered.

...He finally remembered. His father's face. His mother's voice. His kind older brother. The childhood friend, a girl, he would play with every day. Their estate in Liberté et Égalité, the research his father undertook, the smart, loyal AI in the shape of a dog he'd once had.

"...!"

The truth was, he'd never lost it. He'd never been incapable of remembering it. He merely hadn't wanted to recall...the fact that he could never return to that happy world from when he knew

nothing...

His family members had all passed away and were nowhere to be found. The house he could return to was an empty shell of what it once was. Even if he did return, no one would be there waiting for him. Even if he went back to a time of peace, he would never be able to smile as he had back then.

And as things had been taken away from him, he'd only come to realize...the malice of humanity. The cruelty of the world. Its absurdity. Its baseness. Its mercilessness. Its remorselessness.

If he didn't consider those things to be the base elements of the world, he would not have been able to bear it.

He thought he'd remembered his parents' faces, the visage of his warm household, the mechanical dog he'd embraced, but it all lost its color again, became dim and faded away as if crumbling into dust.

The memories of his family weren't burned away by the fires of war. He'd cast them aside...so he wouldn't long for what he could never lay his hands on again. He couldn't deny it any longer.

After glaring at the humans who observed it wordlessly, the white Ameise looked away and turned around in the silent step unique to the Legion. The crouching Dinosauria rose up and followed in its footsteps, shaking off the snow that had piled onto them. They surrounded it as if to guard their delicate queen, hiding it behind their massive frames. Finally, the flock of butterflies turned an oddly obsessive glance in Shin's direction and fell in line, albeit with a hint of reluctance.

As the Merciless Queen disappeared into the darkness of the snow along with its line of retainers...no one gave pursuit.

EPILOGUE

FLOWERS BLOOM NOT ON SNOWY FIELDS

"...Your Highness."

A more ordinary person would have been traumatized by the sight, but sadly, he felt nothing. As Vika looked down at Lerche, who was lying down powerlessly, he couldn't help but affirm to himself that he truly was a monster, human in shape and nothing else.

Lying helplessly near his military boots, atop the flagstones exposed by the melting of the snow, was Lerche. She'd been reduced to only her upper half, and her silvery inner mechanisms were exposed as light-blue circulatory liquid spread beneath her in a puddle.

Just as she had once been in the past.

Looking down at her, Vika said, "Stop breaking at every turn, you seven-year-old."

"Understood. My shame knows no bounds..."

Lerche regarded his all-too-unreasonable rebuke by somehow skillfully dropping her shoulders despite being reduced to only her upper half. Sirins felt no pain. Since they were mechanical dolls that could simply have any damaged parts replaced, they didn't require the alarm system a living, irreplaceable body employed to

alert strain. And so the clockwork girl lying amid the snow and wreckage smiled, without regard for her missing legs, the blue lifeblood spreading out around her, or her exposed mechanical viscera.

Just as she once did.

"Are you unharmed, Your Highness?"

"Obviously."

Because you told me to protect them. So until I've protected the people of this country, until the Legion War ends, I cannot die. And after that...I will live on to the very end... Even with no hopes or dreams to my name.

Because I believe...that was what Lerche, that girl who went ahead of me despite us being the same age, would have wanted.

"Let's go home, Lerche... Carrying you in your current state will actually make things pretty convenient, but just thinking about having to rebuild you from the ground up is giving me a headache."

"My shame knows no—"

"Enough of that."

"And, um... If possible, I would appreciate it if you could add a bit more volume to my chest."

"What is this, your sexual awakening?"

Sighing, he reached out and grabbed her by the back of her head, opening the lock fastening her head to her neck. Vika picked up her head. A human head was heavier than, say, a cat, but while he was royalty, he'd spent most of his life on the battlefield. It was still lighter than an anti-materiel rifle.

Being mechanical dolls, Sirins wouldn't break even when reduced to only their head. After confirming Lerche had automatically shut down upon losing contact with the cooling system stored in her chest, Vika turned around, the cuffs of his uniform fluttering in the wind. With her head in hand, he strode through the fluttering veil of the snow goddess as it raged well beyond its season.

It was like a scene cut straight out of *Salomé*, he noted dully to himself.

Though, that said...

"I've never once kissed you."

Neither the departed girl who served as her basis nor this girl who was as cold as a tombstone.

No one was there to hear the words of his soliloquy as the wind snatched them away.

Leaving his Juggernaut, Rito looked down at the Sirins' siege route again. Several of his comrades also looked down at the grotesque, unnatural path carved by corpses. Surviving until they fell in battle and living to the very end was the pride of the Eighty-Six. That was what they believed as they fought. Embracing that as their identity, they'd fought thus far with that, and nothing else, in mind.

But...

Not bothering to hide his fright and the shiver that crept up from within, Rito thought: How was that different from how the Sirins had laughed as they'd rushed to their demise in this death march...?

Rito had always been afraid of the Sirins. All his comrades were, to some extent. They were creepy. They were indescribably odd, and the Eighty-Six could only watch them from a distance. But now he knew. What frightened him was the idea that those unsettling girls reflected the end of their own road. The vague premonition that at the end of their long battle, they were fated to lie dead atop their own mountain of corpses.

Maybe we were the same as them all along, ever since the Eighty-Sixth Sector. And we called that our pride the whole time. Rushing to our deaths just like them. Laughing all the while.

He'd noticed Raiden standing next to him. He'd fought in the underground hangar, so he grimaced as he looked down at the siege route for the first time. He spat out some Federacy slang Rito didn't know.

"So this is what got your undies in a bunch."

"Vice Cap'n Shuga... I—"

"...Don't."

He cut him off. The palm of his hand then fell on Rito's shoulder in a gesture of concern. But by contrast, his words...

"Everyone else is probably thinking the same thing. But don't

put it into words... You shouldn't have to second-guess the way of life that got you here."

The insulated flight suit didn't even allow the warmth of his hand to reach Rito.

Ludmila's ruined head rolled through the snow beside the siege route. Shin looked down wordlessly at the silent remains of the girl. From between the intermingled remains of crushed Alkonosts, Juggernauts, and Legion leaked a mixture of Liquid Micromachines, subcutaneous circulatory liquid, and several kinds of oil he couldn't recognize, forming an odd multicolored puddle.

As her head rolled, both her striking red hair and her artificial skin were torn off, leaving her as no more than metallic-gray remains. When he picked it up, a crack across her skull widened, causing it to fall apart. A transparent liquid that was rainbow colored at its core—her central processor—and blue blood spilled from her cranium in thick rivulets and pooled on the ground. He could no longer hear any wails or lamentations coming from her.

He was used to seeing human corpses. It was just like they'd told Dustin during their operation in the Republic. And they were just as used to seeing severed heads missing half their faces. It was a common occurrence, a sight he'd witnessed as early as his first squadron in the Eighty-Sixth Sector.

So seeing Ludmila, a Sirin who hadn't been alive to begin with, with an entirely different color of blood, break... Seeing countless of their number break shouldn't have bothered him.

And yet...it hurt. It hurt so much.

Yes, the truth was that it was hard. It had been hard from the very beginning. He recalled the captain of his first squadron, who'd often looked out for him and fussed over helping him because he'd been the youngest new member... He recalled picking up his severed, half-collapsed head.

When had he grown used to this? When had he started treating the fact that others died as a matter of course? As something that wasn't out of the ordinary? When had he shaved that bit away from himself...without even realizing it?

The fragment of the dead person that was trapped inside what

used to be Ludmila was gone now. It disappeared as it was destroyed, and not a trace of it remained anymore. At least, Shin wished that it was so. Looking back, he'd often ask if they wished to die again. Without ever contemplating the coldness behind that question.

Words he'd once heard someone say surfaced in his mind. He couldn't even remember who at this point. But they'd said it to his face. Others said it through the Para-RAID. Sometimes he'd overhear others say it. Mixed into the static of the wireless. Time after time, time after time after time, he'd heard those words.

You monster.

"...Yeah."

That's fitting, thought Shin as he looked up at the siege route. The single most grotesque siege route ever made, formed from the wreckage of the Legion, the Alkonosts, and those mechanical dolls made in the shape of girls. He'd had to tread over it and attack, because if he hadn't, everyone would have died. He'd had to trample over those girls to ensure that no one else would die.

And the same was true for everyone and everywhere else. The Republic trampled over the Eighty-Six, the United Kingdom over the Sirins, and the Federacy over the child soldiers, Vargus, and Mascots. And even those being trampled went on to step over someone else's death in turn to survive in this world.

In which case, if this was what they had to do to survive...

...humans were all monsters.

Each and every one of them.

The faint shimmer of the snow reflected off the 88 mm turret of the Juggernaut sitting atop the siege route, and for the first time, Shin could see that glow only as completely and utterly vile.

"...Shin!"

As Shin stood still, a voice reached his ears. He couldn't hear

the sound of any footsteps. Those were swallowed up by the snow that piled over the marks of battle, and only her silver-bell-like voice reached him.

Tripping over the unfamiliar snowy route, Lena ran up to him, clinging to his body in her rush. His thick flight suit didn't conduct any heat, so he couldn't feel her warmth through it.

"You'll get yourself dirty touching me."

"What are you saying...?!"

She'd likely rushed out in a panic. Lena's uniform was disheveled, as if she'd run out halfway through changing clothes, and she wasn't wearing her jacket over her blouse. Just a coat. She'd likely dropped her military cap somewhere, and amazingly enough, she was running over the snowy ground in her pumps, of all things.

"What in the world are you thinking, coming out here on your own? There could still be Legion around here...!"

"There's nothing here... You already know that."

She gave no reply. In place of any words, her fingers gripped him even more tightly. As if to say Shin might disappear the moment she let go. He'd attempted to utter a *why*, but his voice wouldn't come out.

She should have seen how the siege route made up of the Sirins came to be. And she should have realized the Strike Package had to climb over this to attack. So why did she approach them, without any fear? Why stay by the Eighty-Six, who were whittled down by the battlefield to the extent that normal humans could see them only as monsters at this point?

To begin with, she knew what the battlefield was all about. She'd maintained that defensive line for two long months during the large-scale offensive on the battlefield of the Republic, which had made no preparations to fight out of the belief the war would end soon, with only the faint hope that aid may at some point come.

She repeated retreat after retreat even as she was gradually backed against the wall. Even Shin, accustomed as he was to war, couldn't imagine how utterly despairing maintaining that hopeless defensive line must have been, but Lena knew it all too well.

She knew that Republic Alba citizens were being slaughtered

by the tens of millions... Her brethren and compatriots... She knew the battlefield was a place of wanton death, with no room to hope for the dignity or the sanctity of life. She knew the vileness and baseness people were capable of when cornered.

So why? How?

How could she not give up on this world? How could she believe in a value that was even emptier than a fairy tale, that the world was a beautiful place...?

Lena had said the Eighty-Six gave up on the world out of kindness. That loathing it would be easier than giving up on it. That letting go of their pride would have been that much simpler. In which case, how...? How could she carry an ideal so saccharine that no one could even bear to hear it anymore...?

Why? he wondered.

Why do you persist? Why do you keep going while clinging to that wish? Letting go of it would make it all so much easier, so how can you keep on wishing for it?

No answer came to mind. And Shin didn't know Lena well enough to even come up with any clues to deduce it. Two years ago, he'd bidden her farewell as he'd left for the Special Reconnaissance mission, and he'd met her again only a few months ago. He didn't know what battles she'd fought through. He didn't know what she'd felt, what she'd lamented, what she'd valued, what wish she'd fought for. What desire it was that spurred her to keep fighting.

He'd never even thought to ask. He'd never considered that he wanted to know. He believed he'd achieved something by reuniting with her, but...once he'd met her, he'd made no attempt to understand her.

For the first time, he realized:

I know absolutely nothing about her.

AFTERWORD

Pilot suits are righteous! Hello everyone, this is Asato Asato.

Volume 2? What are you talking about? Whatever—girls in pilot suits are justice. If you were to ask me what's so great about them, I'd be inclined to say it's the idea of armament + girl. Simply splendid. And they're not revealing, but they're still somehow sexy. It's cute. Really, really cute.

Boys in pilot suits are...well... It's not off-limits or anything, but, you know... That's not what makes boys sexy. Or rather, they look sexier when they're dressed really snappily. You know, like in uniform. And, also, uh, when they're in uniform.

Now, then.

Thank you, as always. I bring you *86—Eighty-Six, Volume 5: Death, Be Not Proud*. The title is a nod to the John Donne poem by the same name.

I sincerely thank you all for waiting for so long. It's the pilot suit episode! Her Majesty in a pilot suit! I did it!

And no quips about that not being a pilot suit!

Feast your eyes!!!

- The battlefield this time:

The concept this time was a XXXXX battle done with just polypedal weapons (blotted out for spoiler purposes). It was pretty hard without access to heavy artillery, mortars, or aerial bombing...

By the way, the battlefield that served as inspiration actually exists (sort of), barring a few fictional elements thrown into

the mix, but I'll have to blot it out for spoiler purposes (omitted). I put a few allusions to it in the text itself, though, so anyone who's interested is free to research it. They're some pretty impressive war ruins.

- Dilatant liquid:
Put simply, it's like custard cream.
There's actual footage of custard cream squished between two panes of glass stopping a bullet, but...
Custard cream, really...?

Also, some advertisements! If you go to Dengeki Bunko's home page, you can access the novel-uploading site Kakuyomu, where I'm publishing additional chapters called *Fragmental Neoteny*. They detail Shin's backstory in the Eighty-Sixth Sector. The main concept is the story of a losing battle where a young Shin's eyes gradually grow hollow and dead, so feel free to check it out if you'd like! It requires no registration and can be viewed for free!

Lastly, some acknowledgments.

To Kiyose and Tsuchiya, the editors in charge of me, who've been showing great concern for my remaining hit points. To Shirabii, I'm sorry for adding all these new characters in new uniforms. To I-IV, for answering my unreasonable demands for polypedal units fighting in a snowy environment. To Yoshihara, Volume 1 of the manga adaptation is finally published!

And to you, who picked up this book. Thank you so, so much, as always. Our main pair has kind of done a complete one-eighty after how lighthearted Volume 4 was, but the upcoming Volume 6 will conclude the United Kingdom arc, so they might patch things up..... I hope..... (Ugh...)

In any case, I hope that for even a short moment, I could take you to that battlefield cloaked beneath a white veil, and to his and her sides as they face the divide between them, and the presence of death they should have long grown accustomed to.

Music playing while writing this afterword: "Eve of the
Future" by Ali Project

**Thank you for buying this ebook, published by Yen
On.**

To get news about the latest manga, graphic novels, and light novels from Yen Press, along with special offers and exclusive content, sign up for the Yen Press newsletter.

Sign Up

Or visit us at www.yenpress.com/booklink